



# *Grippul*

Quick gripping and extracting  
hydraulic stub puller

Maintenance

Stub puller



## A winning story since 1961

### The Beginning

At the end of the 1950s, Domenico Franco Agostino became the Italian representative of Albert Otto, a German manufacturer of tube expanders. In 1961 Franco Agostino's Albert Otto Italiana was founded and in 1972, after purchasing an area of 10,000 square metres in the municipality of Bagnolo Cremasco, Maus Italia Sas was established.

### The Growth

In 1976 his son Stefano, a mechanical engineer, joined the company. Together with his father, he studied products, introduced new machinery onto the market and filed the first patents by Maus Italia. Above all, Stefano was firmly convinced that people are the very heart of a company's success. Therefore, he invested in human capital by valuing people and roles, and he surrounded himself with skilled operators as well as technical, commercial and administrative collaborators. The result was a winning, competent and proactive team.

His daughter Anna - also a mechanical engineer - has been working in the company since 2016, giving new impetus and energy to the business her father and grandfather had built.

Father and daughter work together side by side every day to guarantee the excellence of Maus Italia and support all customers worldwide with competence and passion: the company's distinctive traits.



**Stefano Agostino**  
CEO - Mechanical Engineer

**Anna Agostino**  
COO - Mechanical and Management Engineer



## ***In-house production of each component*** ***Workshop 4.0 and 24/7 production control***

The production of Maus Italia branded items is entirely carried out in Bagnolo Cremasco, in the heart of an Italian industrial area 30 km southeast of Milan.

The company boasts a 4.0 workshop equipped with state-of-the-art machinery, an in-house heat treatment room and a final inspection department that allow Maus Italia to independently manage every phase of the manufacturing process of its wide range of products whilst maintaining high quality standards.



## ***Quality first.*** ***Design and development***

One of Maus Italia's strengths is its willingness to understand its customers' needs.

Our technical department is always ready to find operational solutions to the most complex applications, even via feasibility studies. We develop accurate work processes, draw with FEM analyses to verify our mechanical-structural performance and optimise the manufacturing process of each component.

## ***Ready To Deliver***

A well-stocked and complete warehouse of finished products enables Maus Italia ship quickly to customers all over the world according to a ready-to-deliver logic.

The warehouse is fully located within our premises in Bagnolo Cremasco at controlled temperatures and conditions to guarantee the maximum safety and quality of Maus Italia products for all our customers.

## ***Quality, environment and safety policy***

**Research, quality and safety are the watchwords of Maus Italia Spa.**

Maus Italia has several projects underway aimed at increasingly sustainable development and integrates environmental concerns into its business model. The company's actions, behaviour and development choices are focused not only on the short run but rather mainly on a medium and long-term horizon.



## ***Every day in over*** ***80 country*** ***worldwide***

Find an official distributor in your country







# Grippul

*Quick gripping and extracting  
hydraulic stub puller*

The quick gripping stub pullers of the Grippul line are the result of more than forty years of experience in tube extraction gathered by Maus Italia. Grippul was designed and manufactured for quick extraction of stubs from tube sheets.

Grippul, electrically or pneumatically operated versions, is equipped with remote control and it is available in two models depending on the extraction force ( Grippul 11 and Grippul 21).

In combination with BundleCut or Kattex, it facilitates and speeds up the recovery of tube sheets.



## **Quick**

From 4 to 6 extractions per minute



## **Flexible**

Tolerance up to 1 mm ( 0.04" ) of tube inner diameter



## **Inexpensive**

Low tool consumption



## **High quality**

Tube sheet hole protection



# **The extraction process**

Each component was designed according to the most modern and up-to-date technology, especially by analysing the continuous feedbacks we receive from our demanding customers.

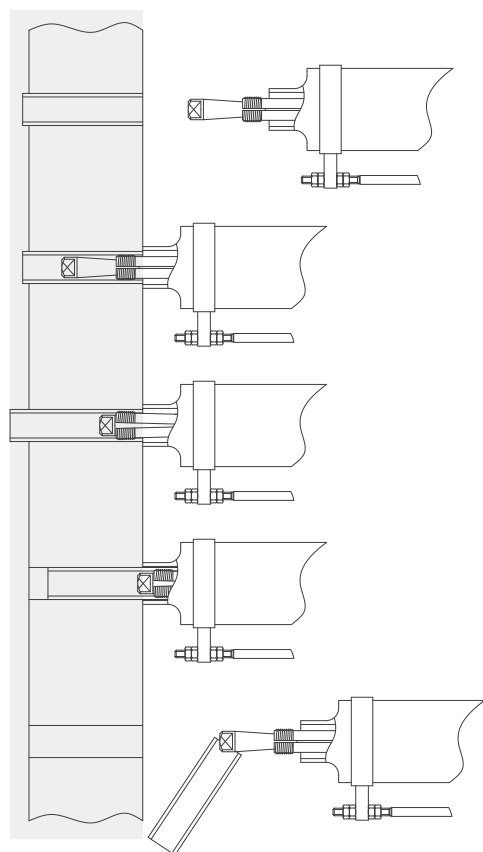

**1 Positioning**

**2 Insertion**

**3 ABTS - Assisted quick connection**  
(Anti-Breaking Tie-Rod System)

**4 Extraction**  
(maximum extraction force 10000 Kg / 22000 lb with GRIPPUL 11  
and 20000 Kg / 44000 lb with GRIPPUL 21)

**5 Quick stub release**



## **| Features that make the difference**

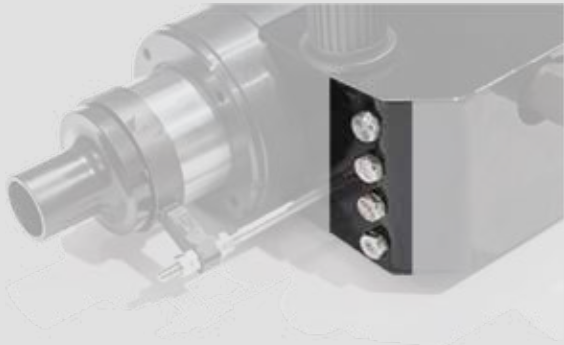

### **ABTS**

The Anti-Breaking Tie-Rod System allows the force with which the jaw penetrates the tube to be regulated to suit the tube's diameter and the material of which it is made. This device means the system is unaffected by the difference in inside diameter of, as much as 1 mm ( 0.04" ), between tubes in the same sheet, preventing tie-rod breakage.



### **OPS**

The electric Over-Pressure Switch cuts off hydraulic fluid delivery when the piston reaches the end of its stroke, preventing unnecessary overpressure in the system.

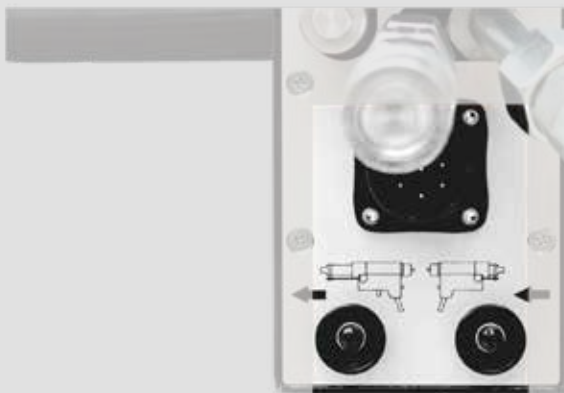

### **RC24**

The RC24 remote control beside the knobs simplifies and speeds up stub extraction. In the electric version it is powered at low voltage 24 Volts.



### **RSR**

The Revolving Support Ring on which the Grippul is suspended during use allows optimal positioning in the tightest spaces.

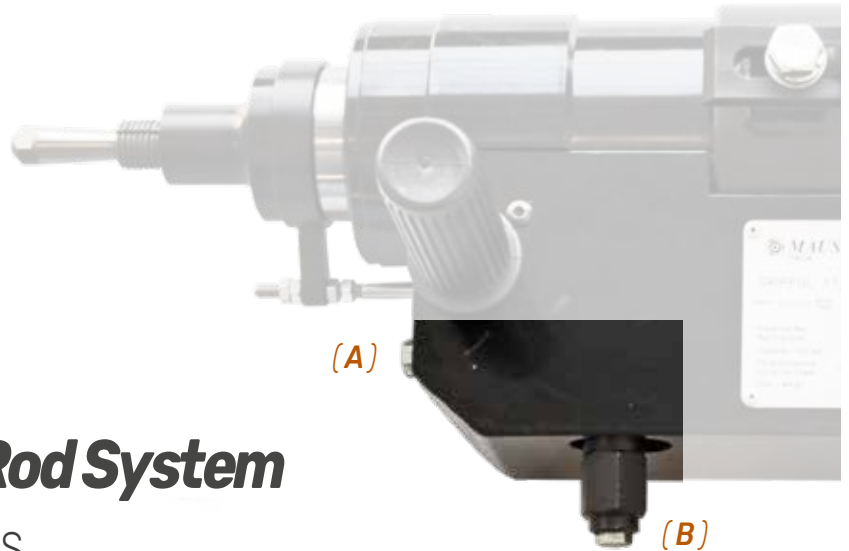

## Anti-Breaking Tie-Rod System

### SAVING AND SAFEGUARDING TOOLS

The Anti-Breaking Tie-Rod System allows the force with which the jaw penetrates the tube to be regulated to suit the tube's diameter and the material of which it is made. This device means the system is unaffected by the difference in inside diameter of, as much as 1 mm (0.04"), between tubes in the same sheet, preventing tie-rod breakage.



GRIPPUL 11 and GRIPPUL 21 are equipped with a set of screws of different lengths stored in the front support **A** to prevent them from being lost.

Depending on which screw is assembled on the hydraulic oil pressure regulating valve **B**, a different gripping force of the jaw is achieved in the stub to be pulled out.

#### Grippul 11

Forza Power (Kgf)	Pressione Pressure (bar)	L (mm)
1500	75	6,80
2000	100	7,50
3000	150	8,75
4000	200	9,30
5000	250	9,80

#### Grippul 21

Forza Power (Kgf)	Pressione Pressure (bar)	L (mm)
2000	50	5,50
3000	75	6,80
4000	100	7,50
6000	150	8,75
9000	225	10,40
12000	300	11,90



The hydraulic oil pressure can be monitored by the help of the supplied manometer.



## Over Pressure Switch



The electric Over-Pressure Switch cuts off hydraulic fluid delivery when the piston reaches the end of its stroke, preventing unnecessary overpressure in the system.

A rigid shaft mounted on the inner piston via a ring slides into the microswitch holder controlling the interruption of the hydraulic oil supply.

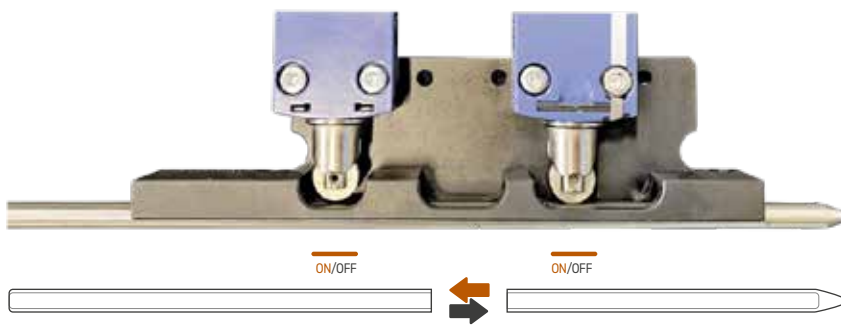

## High Pressure Hydraulic Hoses



High Pressure Hydraulic Hoses, 6 m ( 19.7 ft ) long, are certified for use up to 350 bar ( 5075 psi ). They are equipped with FLAT fittings that reduce dripping during connection and disconnection from GRIPPUL and hydraulic power TP10 unit. They are also equipped with safety systems that prevent a whip effect in the event of a broken hose-fitting connection ( Anti-Whip hoses ).



# Grippul E

**Electric version**



## Grippul 11E

- > Tube (*min < de > max*) 12,7 ÷ 38,1 mm / 1/2" ÷ 1.1/2"
- > Maximum extraction force 10000 Kg / 22000 lb
- > Piston stroke 120 mm / 4.72"
- > Max pressure 350 bar / 5075 psi
- > Remote control power supply 24 V

### > Dimensions:

Width:	500 mm / 19.7"
Depth:	113 mm / 4.5"
Height:	270 mm / 10.6"

- > Weight 23 Kg / 51 lb

### > Case

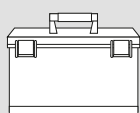

Width:	78 cm / 2.60 ft
Depth:	48 cm / 1.57 ft
Height:	50 cm / 1.64 ft
Gross weight:	48 Kg / 106 lb

## Grippul 21E

- > Tube (*min < de > max*) 25,4 ÷ 63,5 mm / 1" ÷ 2.1/2"
- > Maximum extraction force 20000 Kg / 44000 lb
- > Piston stroke 130 mm / 5.12"
- > Max pressure 350 bar / 5075 psi
- > Remote control power supply 24 V

### > Dimensions:

Width:	600 mm / 23.6"
Depth:	130 mm / 5.1"
Height:	290 mm / 11.4"

- > Weight 35 Kg / 75 lb

### > Case

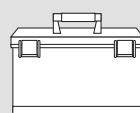

Width:	78 cm / 2.60 ft
Depth:	48 cm / 1.57 ft
Height:	50 cm / 1.64 ft
Gross weight:	60 Kg / 133 lb



## TP10EVV

### Semi-automatic hydraulic power unit

- > Max pressure: 350 bar/5075 psi
- > Oil flow rate:
 

Lt/min ( bar )	US/gpm ( psi )
12 ( 0÷70 )	3.17 ( 0÷1015 psi )
0,9 ( 70÷350 )	0.24 ( 1015÷5075 psi )
- > Hydraulic oil ( not supplied ): 30Lt/8 US Gallon - Viscosità 46
- > Power supply: 1,1 Kw-230/400V-50/60 Hz-3 phase
- > Remote control power supply: 24V
- > IP: 30
- > Dimensions:
 

Width: 680mm / 26.8"
Depth: 500mm / 19.7"
Height: 720mm / 28.3"
- > Weight ( without hydraulic oil ): 86 Kg / 189 lb
- > Box ( power unit + case )



Width:	113 cm / 3.70 ft
Depth:	93 cm / 3.05 ft
Height:	96 cm / 3.15 ft
Gross weight:	211 Kg / 465 lb

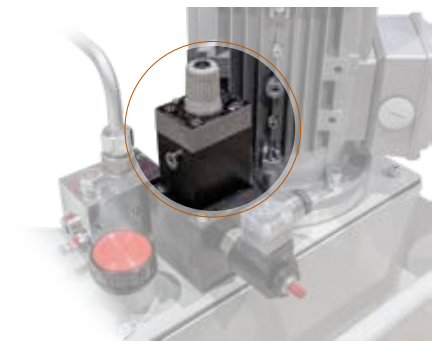

### Flow Rate Adjustment Valve

The Flow Rate Adjustment Valve is required to regulate the flow of hydraulic oil to ensure the best gripping of the jaw in the tube.

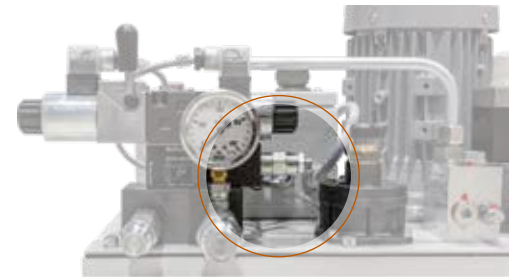

### Pressure Adjustment Valve

The Pressure Adjustment Valve is required to adjust the maximum hydraulic oil pressure when using a TP10EVV power unit with KATTEX 6E and KATTEX 12E hydraulic tube cutters



The TP10EVV power unit can also be used in combination with the semi-automatic hydraulic puller ONLYPUL E





# Grippul P

**Pneumatic version**



## Grippul 11P

- > Tube (*min < de > max*) 12,7 ÷ 38,1 mm / 1/2" ÷ 1.1/2"
- > Maximum extraction force 10000 Kg / 22000 lb
- > Piston stroke 120 mm / 4.72"
- > Max pressure 350 bar / 5075 psi
- > Remote control power supply 6,3 bar / 91.4 Psi
- > Dimensions:
  - Width: 500 mm / 19.7"
  - Depth: 113 mm / 4.5"
  - Height: 270 mm / 10.6"
- > Weight 23 Kg / 51 lb
- > Case

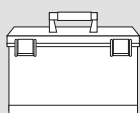

Width: 78 cm / 2.60 ft  
Depth: 48 cm / 1.57 ft  
Height: 50 cm / 1.64 ft  
Gross weight: 48 Kg / 106 lb

## Grippul 21P

- > Tube (*min < de > max*) 25,4 ÷ 63,5 mm / 1" ÷ 2.1/2"
- > Maximum extraction force 20000 Kg / 44000 lb
- > Piston stroke 130 mm / 5.12"
- > Max pressure 350 bar / 5075 psi
- > Remote control power supply 6,3 bar / 91.4 Psi
- > Dimensions:
  - Width: 600 mm / 23.6"
  - Depth: 130 mm / 5.1"
  - Height: 290 mm / 11.4"
- > Weight 35 Kg / 75 lb
- > Case

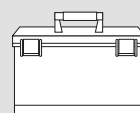

Width: 78 cm / 2.60 ft  
Depth: 48 cm / 1.57 ft  
Height: 50 cm / 1.64 ft  
Gross weight: 60 Kg / 133 lb



### Flow Rate Adjustment Valve

The Flow Rate Adjustment Valve is required to regulate the flow of hydraulic oil to ensure the best gripping of the jaw in the tube.

## TP10PVV

### Semi-automatic hydraulic power unit

- > Max pressure: 350 bar / 5075 psi
- > Oil flow rate:
 

Lt/min ( bar )	US/gpm ( psi )
12 ( 0÷70 )	3.17 ( 0÷1015 psi )
0,9 ( 70÷350 )	0,24 ( 1015÷5075 psi )
- > Hydraulic oil ( not supplied ): 30Lt/8 US Gallon - Viscosità 46
- > Power supply: 1,7 Kw - 7 bar ( 100 psi )
- > Air consumption: 1900 Lt/min ( 67 Cfm ) - 7 bar / 100 psi
- > Dimensions:
  - Width: 680 mm / 26.8"
  - Depth: 500 mm / 19.7"
  - Height: 600 mm / 23.6"
- > Weight ( without hydraulic oil ): 67,5 Kg / 149 lb
- > Box ( power unit + case )



Width:	113 cm / 3.70 ft
Depth:	93 cm / 3.05 ft
Height:	96 cm / 3.15 ft
Gross weight:	192 Kg / 423 lb



### Pressure Adjustment Valve

The Pressure Adjustment Valve is required to adjust the maximum hydraulic oil pressure when using a TP10EVV power unit with KATTEX 6P and KATTEX 12P hydraulic tube cutters



The TP10PVV power unit can also be used in combination with the semi-automatic hydraulic puller ONLYPUL P



# Equipment

- > Transport case
- > Grippul hydraulic puller
- > N°2 hydraulic hoses (length: 6 m)
- > Manometer
- > Set of spare gaskets
- > Set of service keys
- > Instruction manual



Transport case



Grippul hydraulic puller



No. 2 hydraulic hoses



Manometer



Set of spare gaskets



Set of service keys



Instruction manual



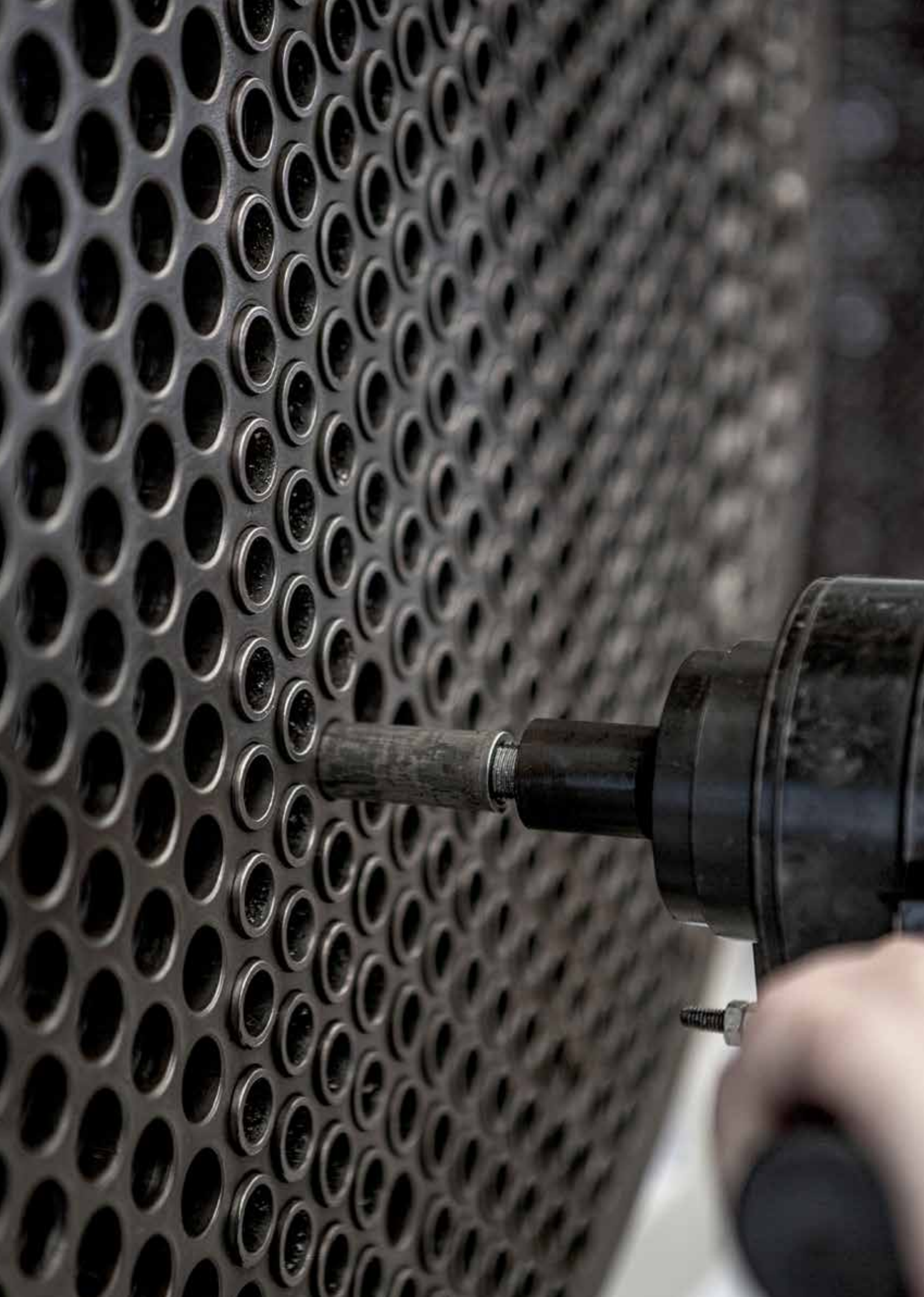

## Optionals



## YRS Set of spare parts

**Model** Set of spare parts for **2** years of working Weight

Grippul 11/E	G11E-YRS-2	2,5 kg / 5.5 lb
Grippul 11/P	G11P-YRS-2	2,5 kg / 5.5 lb
Grippul 21/E	G21E-YRS-2	2,7 kg / 6.0 lb
Grippul 21/P	G21P-YRS-2	2,7 kg / 6.0 lb

## TPB Balancers

**Model** Balancers Range Weight

Grippul 11/E	TPB10	22-25 Kg / 48-55 lb	7,5 Kg / 16.1 lb
Grippul 11/P	TPB10	22-25 Kg / 48-55 lb	7,5 Kg / 16.1 lb
Grippul 21/E	TPB20	30-35 Kg / 66-77 lb	13,1 Kg / 28.9 lb
Grippul 21/P	TPB20	30-35 Kg / 66-77 lb	13,1 Kg / 28.9 lb



## PE Extraction extension

**Tube** Extraction extension **120 mm** Extraction extension **240 mm**

5/8"	PE120-5/8"	PE240-5/8"
3/4"	PE120-3/4"	PE240-3/4"
7/8"	PE120-7/8"	PE240-7/8"
1.1/4"	PE120-1.1/4"	PE240-1.1/4"
1.1/2"	PE120-1.1/2"	PE240-1.1/2"

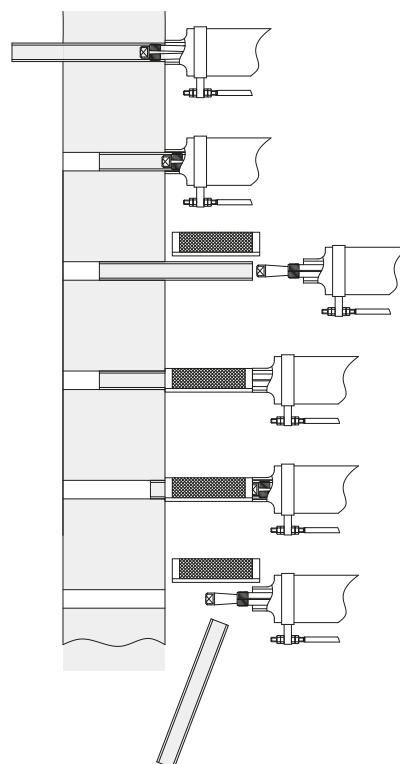







# Grippul 11

# Tool table

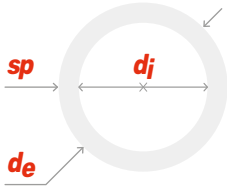

COLLAR TIE-ROD JAW CONE

Tube			Expansion		Jaw	Cone	Tie-rod	Collar			
$d_e$		$sp$	$d_j$								
inches	mm	B.W.G	inches	mm	inches	mm	Cod.	Cod.			
1/2" (12,7)	14	0,083	2,11	0,334	8,5	0,335 ÷ 0,393	8,5 ÷ 10,0	<b>G11J-02</b>			
	16	0,065	1,65	0,370	9,4	0,347 ÷ 0,433	9,5 ÷ 11,0	<b>G11J-02/A</b>	<b>G11C 02÷03</b>	<b>G11T 02÷03</b>	<b>TPC-14</b>
	17	0,058	1,47	0,384	9,7						
	18	0,049	1,24	0,402	10,2						
	19	0,042	1,07	0,416	10,5	0,393 ÷ 0,472	10,5 ÷ 12,0	<b>G11J-03</b>			
	20	0,035	0,89	0,430	10,9						
5/8" (15,9)	14	0,083	2,11	0,459	11,7	0,452 ÷ 0,512	11,5 ÷ 13,0	<b>G11J-04</b>	<b>G11C 04÷2</b>	<b>G11T 04÷2</b>	<b>TPC-18</b>
	15	0,072	1,83	0,481	12,2	0,492 ÷ 0,551	12,5 ÷ 14,0	<b>G11J-1</b>			
	16	0,065	1,65	0,495	12,6						
	18	0,049	1,24	0,527	13,4						
	19	0,042	1,07	0,541	13,7	0,551 ÷ 0,610	14,0 ÷ 15,5	<b>G11J-2</b>			
	20	0,035	0,89	0,555	14,1						
22	0,028	0,71	0,569	14,5							
3/4" (19,0)	12	0,109	2,77	0,532	13,4	0,531 ÷ 0,610	13,5 ÷ 15,5	<b>G11J-2/A</b>	<b>G11C 2/A÷8</b>	<b>G11T 2/A÷8</b>	<b>TPC-21</b>
	13	0,095	2,41	0,560	14,2	0,571 ÷ 0,650	14,5 ÷ 16,5	<b>G11J-3</b>			
	14	0,083	2,11	0,584	14,8						
	15	0,072	1,83	0,606	15,3						
	16	0,065	1,65	0,620	15,7	0,610 ÷ 0,689	15,5 ÷ 17,5	<b>G11J-4</b>			
	18	0,049	1,24	0,652	16,5						
	19	0,042	1,07	0,666	16,8	0,669 ÷ 0,748	17,0 ÷ 19,0	<b>G11J-5</b>			
	20	0,035	0,89	0,680	17,2						
22	0,028	0,71	0,694	17,6							
7/8" (22,2)	12	0,109	2,77	0,657	16,6	0,650 ÷ 0,728	16,5 ÷ 18,5	<b>G11J-6</b>	<b>G11C 2/A÷8</b>	<b>G11T 2/A÷8</b>	<b>TPC-25</b>
	14	0,083	2,11	0,709	18,0	0,728 ÷ 0,807	18,5 ÷ 20,5	<b>G11J-7</b>			
	16	0,065	1,65	0,745	18,9						
	18	0,049	1,24	0,777	19,7						
	19	0,042	1,07	0,791	20,0	0,787 ÷ 0,866	20,0 ÷ 22,0	<b>G11J-8</b>			
	20	0,035	0,89	0,805	20,4						
22	0,028	0,71	0,819	20,8							

Critical tube dimensions at the limit of extraction capacity for Grippul 11 (10,000 kg / 22,000 lb)  
It depends on the tube material and on the expansion (tube sheet with or without grooves, length of expansion and expansion level)

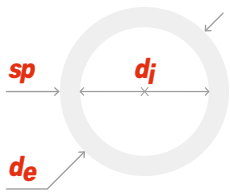

Tube			Expansion		Jaw	Cone	Tie-rod	Collar	
de	sp		dj		inches	mm	Cod.	Cod.	Cod.
inches mm	B.W.G	inches mm	inches mm	inches	mm	Cod.	Cod.	Cod.	
1" (25,4)	10	0.134 3,40	0.732 18,6	0.728 ÷ 0.807	18,5 ÷ 20,5	G11J-8/A	G11C 8/A÷11	G11T 8/A÷20	TPC-28
	12	0.109 2,77	0.782 19,8	0.767 ÷ 0.846	19,5 ÷ 21,5	G11J-9			
	13	0.095 2,41	0.810 20,6	0.827 ÷ 0.906	21,0 ÷ 23,0	G11J-9/A			
	14	0.083 2,11	0.834 21,2	0.866 ÷ 0.945	22,0 ÷ 24,0	G11J-10			
	15	0.072 1,83	0.856 21,7	0.925 ÷ 1.004	23,5 ÷ 25,5	G11J-11			
	16	0.065 1,65	0.870 22,1						
	18	0.049 1,24	0.902 22,9						
	19	0.042 1,07	0.916 23,2						
	20	0.035 0,89	0.930 23,6						
	22	0.028 0,71	0.944 24,0						
1.1/4" (31,8)	10	0.134 3,40	0.982 25,0	0.964 ÷ 1.043	24,5 ÷ 26,5	G11J-12	G11C 12÷15	G11T 8/A÷20	TPC-34
	11	0.120 3,05	1.010 25,7	1.043 ÷ 1.122	26,5 ÷ 28,5	G11J-13			
	12	0.109 2,77	1.032 26,2	1.102 ÷ 1.181	28,0 ÷ 30,0	G11J-14			
	13	0.095 2,41	1.060 27,0	1.161 ÷ 1.240	29,5 ÷ 31,5	G11J-15			
	14	0.083 2,11	1.084 27,6						
	16	0.065 1,65	1.120 28,5						
	18	0.049 1,24	1.152 29,3						
	19	0.042 1,07	1.166 29,6						
1.1/2" (38,1)	8	0.165 4,19	1.170 29,7	1.161 ÷ 1.240	29,5 ÷ 31,5	G11J-16	G11C 16÷20	G11T 8/A÷20	TPC-41
	10	0.134 3,40	1.232 31,3	1.240 ÷ 1.319	31,5 ÷ 33,5	G11J-17			
	11	0.120 3,05	1.260 32,0	1.299 ÷ 1.378	33,0 ÷ 35,0	G11J-18			
	12	0.109 2,77	1.282 32,5	1.358 ÷ 1.437	34,5 ÷ 36,5	G11J-19			
	13	0.095 2,41	1.310 33,3	1.417 ÷ 1.496	36,0 ÷ 38,0	G11J-20			
	14	0.083 2,11	1.334 33,9						
	15	0.072 1,83	1.356 34,4						
	16	0.065 1,65	1.370 34,8						
	18	0.049 1,24	1.402 35,6						
	19	0.042 1,07	1.416 35,9						
20	0.035 0,89	1.430 36,3							
22	0.028 0,71	1.444 36,7							

Critical tube dimensions at the limit of extraction capacity for Grippul 11 (10,000 kg / 22,000 lb)  
It depends on the tube material and on the expansion (tube sheet with or without grooves, length of expansion and expansion level)

# Grippul 21

## Tool table

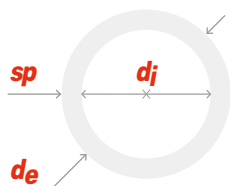

Tube			Expansion		Jaw	Cone	Tie-rod	Collar					
$d_e$		$sp$	$d_j$										
inches	mm	B.W.G	inches	mm	inches	mm	Cod.	Cod.	Cod.				
3/4" (19,0)	12	0.109	2,77	0.532	13,4	0.531 ÷ 0.610	13,5 ÷ 15,5	<b>G11J-2/A</b>	<b>G11C 2/A÷8</b>	<b>G21T 2/A÷8</b>	<b>TPC-21</b>		
	13	0.095	2,41	0.560	14,2	0.571 ÷ 0.650	14,5 ÷ 16,5	<b>G11J-3</b>					
	14	0.083	2,11	0.584	14,8								
	15	0.072	1,83	0.606	15,3	0.610 ÷ 0.689	15,5 ÷ 17,5	<b>G11J-4</b>					
	16	0.065	1,65	0.620	15,7								
	18	0.049	1,24	0.652	16,5	0.669 ÷ 0.748	17,0 ÷ 19,0	<b>G11J-5</b>					
	19	0.042	1,07	0.666	16,8								
	20	0.035	0,89	0.680	17,2	22	0.028	0,71				0.694	17,6
7/8" (22,2)	12	0.109	2,77	0.657	16,6	0.650 ÷ 0.728	16,5 ÷ 18,5	<b>G11J-6</b>	<b>G11C 2/A÷8</b>	<b>G21T 2/A÷8</b>	<b>TPC-25</b>		
	14	0.083	2,11	0.709	18,0	0.728 ÷ 0.807	18,5 ÷ 20,5	<b>G11J-7</b>					
	16	0.065	1,65	0.745	18,9								
	18	0.049	1,24	0.777	19,7	0.787 ÷ 0.866	20,0 ÷ 22,0	<b>G11J-8</b>					
	19	0.042	1,07	0.791	20,0								
	20	0.035	0,89	0.805	20,4	22	0.028	0,71				0.819	20,8
1" (25,4)	10	0.134	3,40	0.732	18,6	0.728 ÷ 0.846	18,5 ÷ 21,5	<b>G21J-8/A</b>	<b>G21C 8/A÷11</b>	<b>G21T 8/A÷11</b>	<b>TPC-28</b>		
	12	0.109	2,77	0.782	19,8	0.768 ÷ 0.886	19,5 ÷ 22,5	<b>G2J-9</b>					
	13	0.095	2,41	0.810	20,6	0.827 ÷ 0.945	21,0 ÷ 24,0	<b>G21J-9/A</b>					
	14	0.083	2,11	0.834	21,2								
	15	0.072	1,83	0.856	21,7	0.866 ÷ 0.984	22,0 ÷ 24,0	<b>G21J-10</b>					
	16	0.065	1,65	0.870	22,1								
	18	0.049	1,24	0.902	22,9	0.925 ÷ 1.043	23,5 ÷ 26,5	<b>G21J-11</b>					
	19	0.042	1,07	0.916	23,2								
	20	0.035	0,89	0.930	23,6	22	0.028	0,71				0.944	24,0
	1.1/4" (31,8)	10	0.134	3,40	0.982	25,0	0.965 ÷ 1.083	24,5 ÷ 27,5				<b>G21J-12</b>	<b>G21C 12÷15</b>
11		0.120	3,05	1.010	25,7	1.043 ÷ 1.161	26,5 ÷ 29,5	<b>G21J-13</b>					
12		0.109	2,77	1.032	26,2								
13		0.095	2,41	1.060	27,0	1.102 ÷ 1.220	28,0 ÷ 31,0	<b>G21J-14</b>					
14		0.083	2,11	1.084	27,6								
16		0.065	1,65	1.120	28,5	1.161 ÷ 1.280	29,5 ÷ 32,5	<b>G21J-15</b>					
18		0.049	1,24	1.152	29,3								
19		0.042	1,07	1.166	29,6	20	0.035	0,89	1.180	30,0			
22	0.028	0,71	1.194	30,4									

Dimensioni critiche dei tubi al limite della capacità di estrazione del Grippul 21 ( 20000 Kg / 44000 lb )  
 Dipende dal materiale del tubo e dall'espansione ( con o senza canalini nella piastra tubiera, lunghezza dell'espansione e livello di espansione )



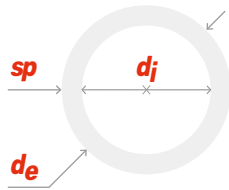

Tube			Expansion			Jaw	Cone	Tie-rod	Collar		
<b>de</b>		<b>B.W.G</b>	<b>sp</b>		<b>dj</b>						
inches	mm		inches	mm	inches	mm	Cod.	Cod.	Cod.		
1.1/2" (38,1)	8	0.165	4,19	1.170	29,7	1.161 ÷ 1.280	29,5 ÷ 32,5	<b>G21J-16</b>			
	10	0.134	3,40	1.232	31,3						
	11	0.120	3,05	1.260	32,0	1.240 ÷ 1.358	31,5 ÷ 34,5	<b>G21J-17</b>			
	12	0.109	2,77	1.282	32,5						
	13	0.095	2,41	1.310	33,3						
	14	0.083	2,11	1.334	33,9	1.299 ÷ 1.417	33,0 ÷ 36,0	<b>G21J-18</b>	<b>G21C 16÷20</b>	<b>G21T 16÷20</b>	<b>TPC-41</b>
	15	0.072	1,83	1.356	34,4						
	16	0.065	1,65	1.370	34,8						
	18	0.049	1,24	1.402	35,6	1.358 ÷ 1.476	34,5 ÷ 37,5	<b>G21J-19</b>			
	19	0.042	1,07	1.416	35,9						
1.3/4" (44,4)	10	0.134	3,40	0.482	37,6	1.417 ÷ 1.535	36,0 ÷ 39,0	<b>G21J-20</b>			
	11	0.120	3,05	1.510	38,3						
	12	0.109	2,77	1.532	38,8	1.476 ÷ 1.594	37,5 ÷ 40,5	<b>G21J-21</b>			
	14	0.083	2,11	1.584	40,2						
	15	0.072	1,83	1.606	40,7	1.555 ÷ 1.673	39,5 ÷ 42,5	<b>G21J-22</b>	<b>G21C 21÷26</b>	<b>G21T 21÷26</b>	<b>G21 TPC-48</b>
	16	0.065	1,65	1.620	41,1						
	18	0.049	1,24	1.652	41,9						
	19	0.042	1,07	1.666	42,2	1.634 ÷ 1.752	41,5 ÷ 44,5	<b>G21J-23</b>			
	20	0.035	0,89	1.680	42,6						
	2" (50,8)	10	0.134	3,40	1.732	44,0	1.713 ÷ 1.831	43,5 ÷ 46,5	<b>G21J-24</b>		
12		0.109	2,77	1.782	45,2						
13		0.095	2,41	1.810	46,0	1.791 ÷ 1.909	45,5 ÷ 48,5	<b>G21J-25</b>	<b>G21C 21÷26</b>	<b>G21T 21÷26</b>	<b>G21 TPC-54</b>
14		0.083	2,11	1.834	46,6						
16		0.065	1,65	1.870	47,5						
18		0.049	1,24	1.884	47,8	1.870 ÷ 1.988	47,5 ÷ 50,5	<b>G21J-26</b>			
2.1/2" (63,5)	3	0.259	6,58	1.982	50,3	1.968 ÷ 2.087	50,0 ÷ 53,0	<b>G21J-27</b>			
	4	0.238	6,05	2.024	51,4						
	5	0.220	5,59	2.060	52,3	2.067 ÷ 2.185	52,5 ÷ 55,5	<b>G21J-28</b>			
	6	0.203	5,16	2.094	53,2						
	7	0.180	4,57	2.140	54,3	2.146 ÷ 2.205	54,5 ÷ 57,5	<b>G21J-29</b>			
	9	0.148	4,76	2.204	56,0						
	10	0.134	3,40	2.232	56,7						
	11	0.120	3,05	2.260	57,4	2.224 ÷ 2.343	56,5 ÷ 59,5	<b>G21J-30</b>	<b>G21C 27÷32</b>	<b>G21T 27÷32</b>	<b>G21 TPC-68</b>
	12	0.109	2,77	2.282	57,9						
	14	0.083	2,11	2.334	59,3						
1.5/8"	15	0.072	1,83	2.356	59,8	2.303 ÷ 2.421	58,5 ÷ 61,5	<b>G21J-31</b>			
	16	0.065	1,65	2.370	60,2						
	18	0.049	1,24	2.402	61,0	2.382 ÷ 2.500	60,5 ÷ 63,5	<b>G21J-32</b>			

Dimensioni critiche dei tubi al limite della capacità di estrazione del Grippul 21 ( 20000 Kg / 44000 lb )  
 Dipende dal materiale del tubo e dall'espansione ( con o senza canalini nella piastra tubiera, lunghezza dell'espansione e livello di espansione )

# Heat exchanger's world

---

**MAUS ITALIA SPA IS THE WORLD LEADING MANUFACTURER OF TOOLS AND MACHINES FOR THE PRODUCTION AND MAINTENANCE OF HEAT EXCHANGERS**



**Maus Italia S.p.A.**

SP 415 KM 30 ( nuova strada di arrocco )  
26010 Bagnolo Cremasco ( CR ) Italy  
PIVA: 00141010199

Telefono: +39 0373 2370

expo@mausitalia.it  
www.mausitalia.it







**mausitalia.it**