



# Maintenance

Machines and tools for maintenance of heat exchangers,  
boilers and aircoolers





# Heat exchanger's world

---

**MAUS ITALIA SPA IS THE WORLD LEADING MANUFACTURER OF TOOLS AND MACHINES FOR THE PRODUCTION AND MAINTENANCE OF HEAT EXCHANGERS**





# A winning story since 1961

## The Beginning

Domenico Franco Agostino was born in Messina in 1917. Aged only 14, he decided to seek his fortune in the North, his destination being Milan. Aged 28, after serving throughout his youth for seven long years during World War II, he began his career determined to achieve his dream of setting up his own business. During the war years, Franco met by correspondence Luisa Capoferri, a girl from Crema soon to become Mrs Agostino, who would be one of the pillars of the future business.

His business card read: 'Franco Agostino Industrial Dealer'. The two made contact with manufacturers of welding machines, abrasives, thermometers and pressure gauges, an industry Franco was familiar with thanks to his apprenticeship in Milan. In 1959, by pure coincidence Franco became the Italian representative of Albert Otto, a German manufacturer of tube expanders.

In 1960, Albert Otto's owners - elderly and childless - put forth to the Agostino family to manufacture the German product directly in Italy: in 1961 Franco Agostino's Albert Otto Italiana was founded and in 1972, after purchasing an area of 10,000 square metres in the municipality of Bagnolo Cremasco, Maus Italia Sas was established.

## The Growth

In 1976 his son Stefano, a mechanical engineer, joined the company. Together with his father, he studied products, introduced new machinery onto the market and filed the first patents by Maus Italia.

Stefano proceeded with determination: he believed in technological innovation and market diversification achieved through a widespread sales organisation allowing the brand 'Maus Italia' to expand all over the world.

Above all, Stefano was firmly convinced that people are the very heart of a company's success. Therefore, he invested in human capital by valuing people and roles, and he surrounded himself with skilled operators as well as technical, commercial and administrative collaborators. The result was a winning, competent and proactive team.

His daughter Anna - also a mechanical engineer - has been working in the company since 2016, giving new impetus and energy to the business her father and grandfather had built.

Father and daughter work together side by side every day to guarantee the excellence of Maus Italia and support all customers worldwide with competence and passion: the company's distinctive traits.

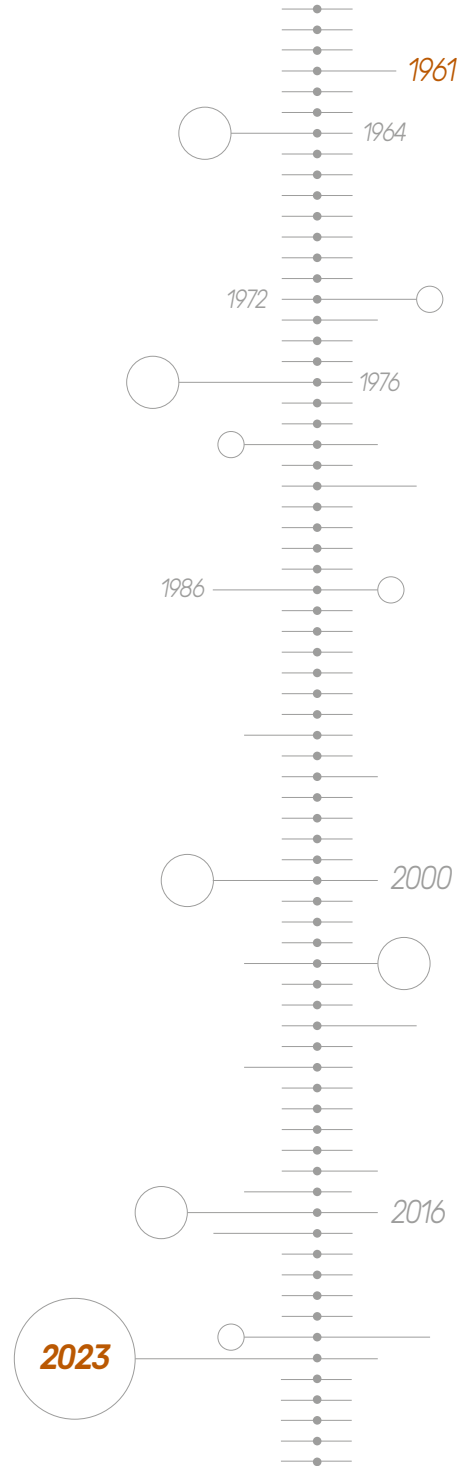

**Stefano Agostino**

*CEO - Mechanical Engineer*

**Anna Agostino**

*COO - Mechanical and Management Engineer*



## A close team

# Leading the industry worldwide

Maus Italia relies on a team of 63 staff who devote themselves daily to the design and production of Maus' products with care and competence. Rigorous procedures, commitment to R&D and passion for working with an innovative, sustainable and flexible approach ensure the highest quality in products and services.

Experience, quality and continuous innovation make Maus Italia the number one company in its sector Europe-wide and place it at the top of the world rankings. Such achievement is also the result of the commitment and synergy of the entire company staff: teamwork is one of the keys to Maus Italia's success.

## Headquarters on **35000** sq m



## Every day in over **80** country worldwide

Our extensive sales network guarantees full availability and satisfies even the most demanding customers. In its over 60 years up and running, Maus Italia has built an efficient business organisation and a dense international sales network, with agents and distributors in more than 80 countries all over the world.

Find an official distributor  
in your country





## In-house production of each component Workshop 4.0 and 24/7 production control

The production of Maus Italia branded items is entirely carried out in Bagnolo Cremasco, in the heart of an Italian industrial area 30 km southeast of Milan.

The company boasts a 4.0 workshop equipped with state-of-the-art machinery, an in-house heat treatment room and a final inspection department that allow Maus Italia to independently manage every phase of the manufacturing process of its wide range of products whilst maintaining high quality standards.

## Quality first. Design and development

One of Maus Italia's strengths is its willingness to understand its customers' needs.

Our technical department is always ready to find operational solutions to the most complex applications, even via feasibility studies. We develop accurate work processes, draw with FEM analyses to verify our mechanical-structural performance and optimise the manufacturing process of each component.





## Ready To Deliver. Optimisation and efficiency

A well-stocked and complete warehouse of finished products enables Maus Italia ship quickly to customers all over the world according to a ready-to-deliver logic.

The warehouse is fully located within our premises in Bagnolo Cremasco at controlled temperatures and conditions to guarantee the maximum safety and quality of Maus Italia products for all our customers.

## Quality, environment and safety policy

**Research, quality and safety are the watchwords of Maus Italia Spa.**

Maus Italia has several projects underway aimed at increasingly sustainable development and integrates environmental concerns into its business model. The company's actions, behaviour and development choices are focused not only on the short run but rather mainly on a medium and long-term horizon.



# Index

pag

## **Welcome**

**Maus Italia presentation - *The story, the company and know-how*** 3

## **Tube bundle extraction and handling**

**Aerial extractor for heat exchanger tube bundles - *Mef Express HT*** 10

**Aerial transporter of the tube bundles - *Bundle Tutor Lifter*** 30

**Trasporter for the handling of the tube bundles - *Bundle Tutor Mobil*** 48

**Tube bundle puller for the extraction and transportation of tube bundles - *Mef Mobil*** 58

**Tube bundle puller to be mounted on the truck - *Mef TT 23*** 62

**Fixed tube bundle puller for the extraction of tube bundles - *Mef Fixed NAVY*** 66

## **Tube cleaning**

**Mechanical internal cleaning with rigid shafts for heat exchanger tubes - *Hardscal*** 70

## **Tube & tube bundle cutting**

**Band saw for the dismantling of tube bundle - *BundleCut Evolution Plus*** 76

**Hydraulically operated internal single tube cutter - *Kattex Cut*** 88

**Motor operated internal single tube cutter - *F/794*** 112

## **Stub & tube extraction**

**Quick gripping and extracting hydraulic stub puller - *Grippul*** 116

**Automatic hydraulic tube pulling for high speed extraction of tubes - *Runpul*** 134

**Semi-automated hydraulic tube puller for small-scale maintenance - *Onlypul*** 158

## **Manual tools**

**Equipment for the manual maintenance - *F/790 - F/791 - F/792 - F/793 - F/789*** 176



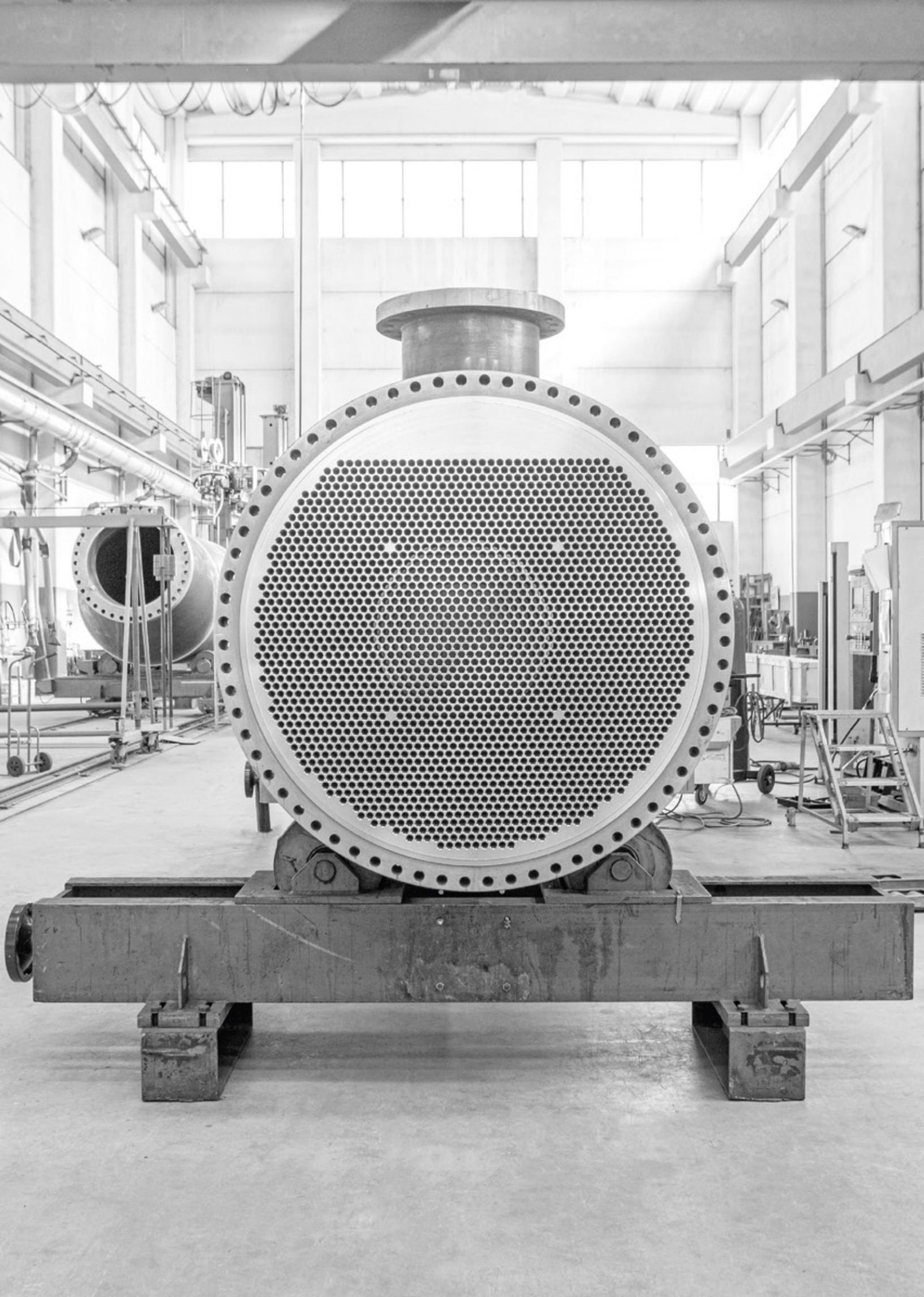







# *Mef Express HT*

*Aerial extractor for heat exchanger tube bundles*

# Mef Express HT

*To ensure minimum downtime and protection of the tube bundle during extraction*

Maus Italia presents, for the extraction and insertion of tube bundles in the plant, a complete new range of Mef Express HT aerial tube bundle extractors with dedicated solutions for handling by crane for maintenance at great heights.

Years of evolution of the Mef Express product series have allowed the design to be revisited, making the Mef Express HT ( High Technology ) aerial tube bundle extractors of today even more lightweight, more flexible and easier to handle.

Starting from the numerous standard products that cover common market requests, Maus Italia is also able to provide custom solutions to solve extreme cases with ATEX / OFF-SHORE versions.

**For tube bundles up to 125 T in weight**





# Focus features

Standard features



NO damage

## Protective

The Mef Express HT aerial extractor carefully supports the tube bundle during extraction and insertion and ensures perfect balance along its longitudinal axis, eliminating the risk of damaging the baffles or crushing the tubes.



User-friendly

## Operational simplicity

The controls on the supplied remote control make the Mef Express HT extremely simple and intuitive to use, guaranteeing the operator full control of the extraction or insertion sequence.



Planetary gearbox

## Longlasting epicyclic power

The use of powerful planetary gearboxes guarantees greater reliability and robustness than chain systems, thus minimising the need for maintenance.

Optional features

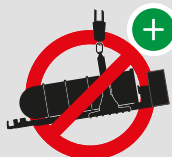

NO overturning

## Electronic overturning control

The Mef Express HT can be supplied, upon request, with the innovative EOC system which allows the handling of loads in complete safety by inhibiting any incorrect commands which would compromise stability.



ATEX

## ATEX certification

The Mef Express HT aerial extractor can, upon request, be manufactured in accordance with the ATEX directive in an explosion proof configuration for use in environments with a potentially explosive atmosphere.



Off shore

## DNV certification for FPSO and offshore platforms

Maus Italia can, upon request, design and produce DNV approval type Mef Express NAVY aerial tube bundle extractors for OFFSHORE applications, Mef fixed NAVY stationary versions and Mef Mobile NAVY self-propelled caterpillar versions.



Low Temp

## Not afraid of the cold

The Mef Express HT aerial extractor can be supplied, upon request, in the special version, suitable for operating at the very lowest temperatures.



Customized

## Adapts according to need

Maus Italia can design the Mef Express HT aerial extractor, upon request and subject to technical verification, for bundle sizes and weights different from our standard product. Special paints for colour, composition and thickness are possible.

## Electrowelded steel ring for lifting the extractor

Maus Italia applies targeted solutions to solve customer problems.

The ring can be:

- Circular
- Oval
- Divisible in three parts



### Circular

Solution for all sizes of models up to the Mef express HT 2045/75

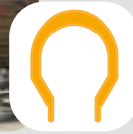

### Oval

Solution to facilitate the handling of the extractor in small spaces, mainly requested for OFF SHORE application

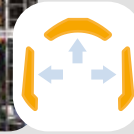

### Divisible in 3 parts

Solution for sizes of models from the Mef express HT 2545/75 upwards to facilitate transport on the plant, as well as shipping

## Adjustable hydraulic vices

for anchoring the machine to the exchanger flange

- left and right side synchronous movement (standard)
- left and right independent movement (optional)

## Support trolleys

to support the tube bundle

- with manual controls (standard)
- hydraulically operated (optional)

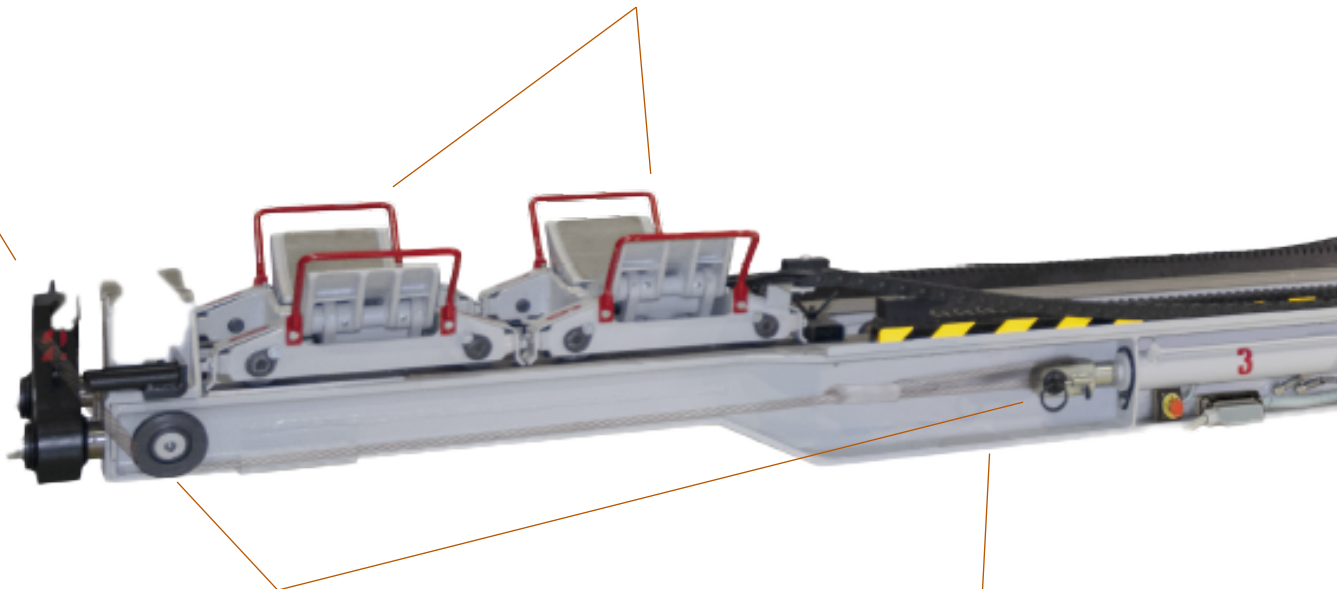

## Hydraulic rope tensioning system

for safe anchoring of the extractor to the exchanger.

- left and right side synchronous movement (standard)
- left and right side independent movement (optional)

## Electrowelded steel structure

to support the weight of the tube bundle





### Lifting points

- for lifting the extractor
- single central / side (standard)
  - double side (optional)

### Engine unit

- sized for the selected model
- with air cooling (standard)
  - with liquid cooling (optional)

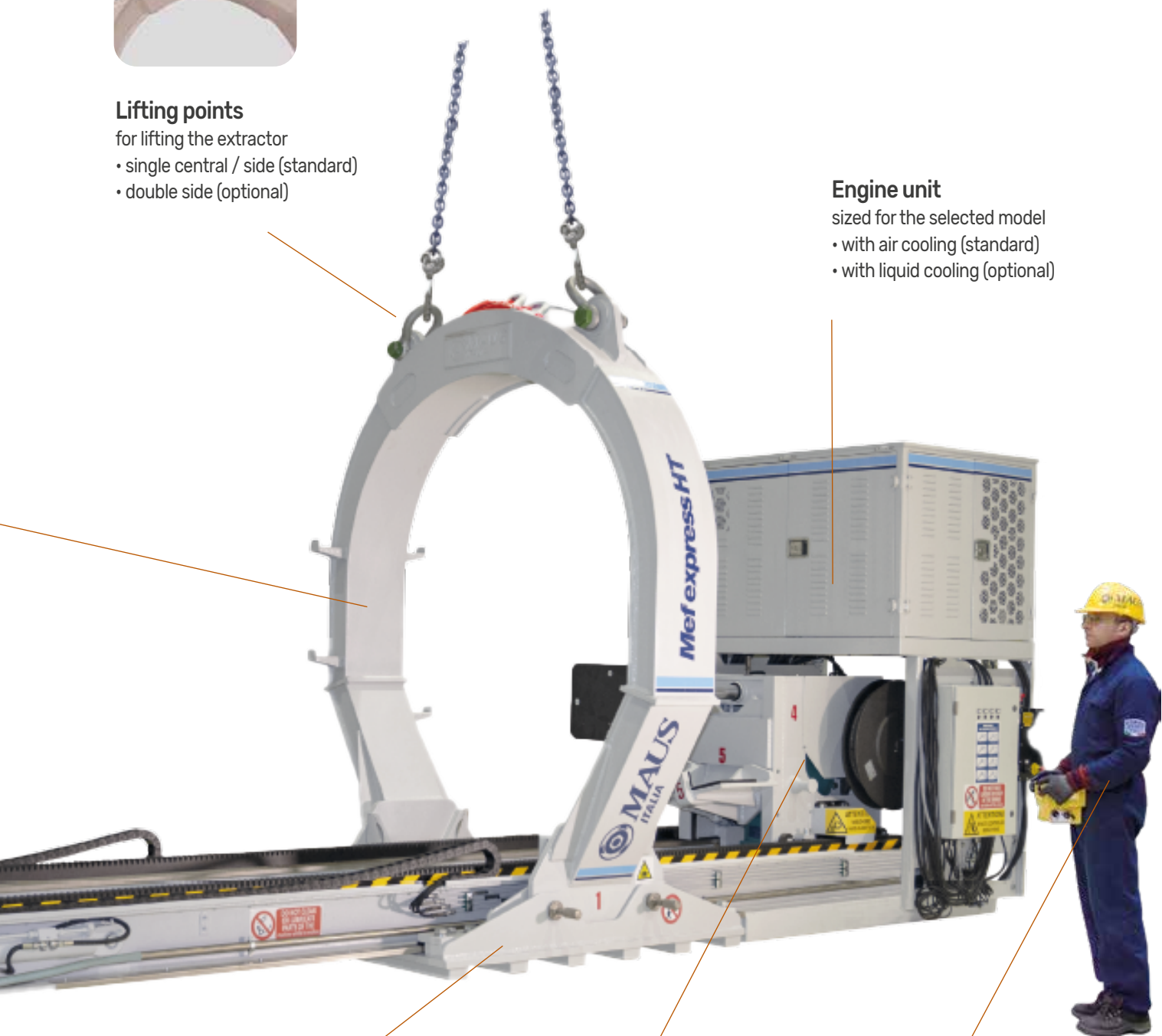

### Extractor base

- for balancing during extraction
- the large support area guarantees stability during the overhead balancing phase

### Main carriage

- for coupling/pulling/pushing the tube bundle
- with planetary gearbox (standard)
  - increased pulling force (optional)

### Remote control

- for controlling the available hydraulic movements
- with connection cable (standard)
  - radio control (optional in addition to the standard)

**1** Anchoring to the shell

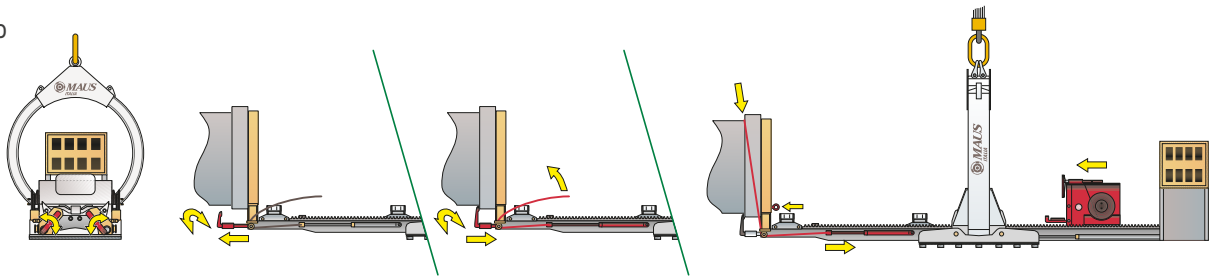

**2** Pull the tubesheet with rope

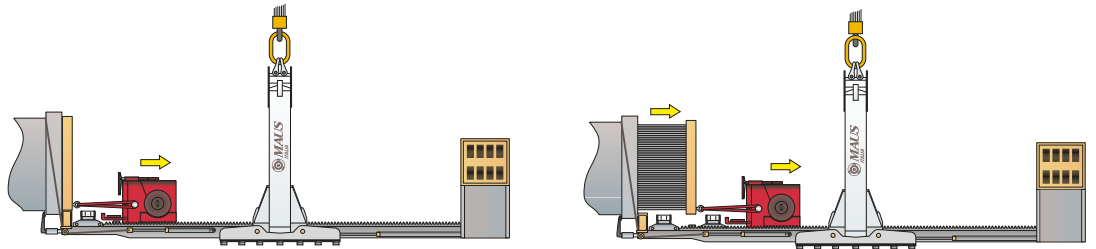

**3** Coupling and start of extraction

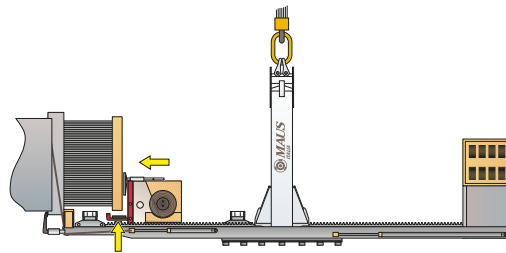

**4** Extraction and support

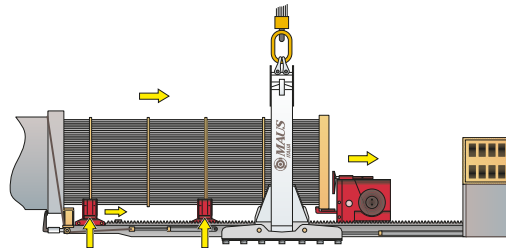

**5** End of extraction and balancing

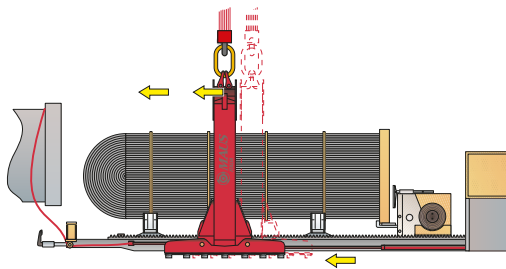

**6** Release from shell and depositing on ground using a crane

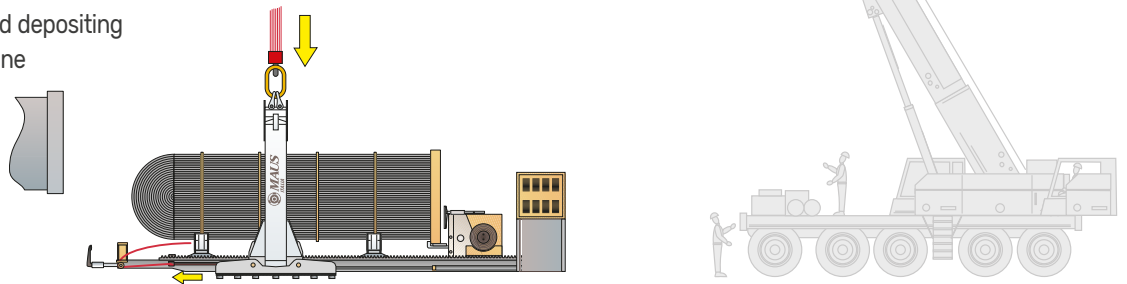





Anchoring to the shell **1**

# Extraction sequence



Pull the tubesheet with rope **2**



Coupling and start of extraction **3**

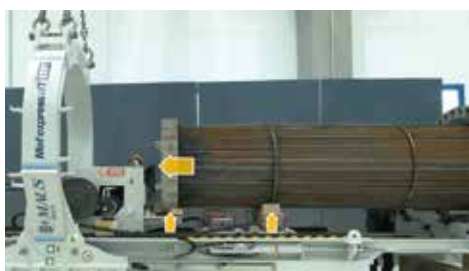

Extraction and support **4**



End of extraction and balancing **5**



Release from shell and depositing on ground using a crane **6**



## Longlasting epicyclic power



The use of powerful planetary gearboxes (between 1 and 3 according to pulling force) improves reliability and makes possible the increase of pulling force compared to chain systems, thus minimising maintenance of the transmission components.

Components such as these make the Mef Express HT extractor a high-performance machine, capable of standing out in the world of heat exchanger maintenance.

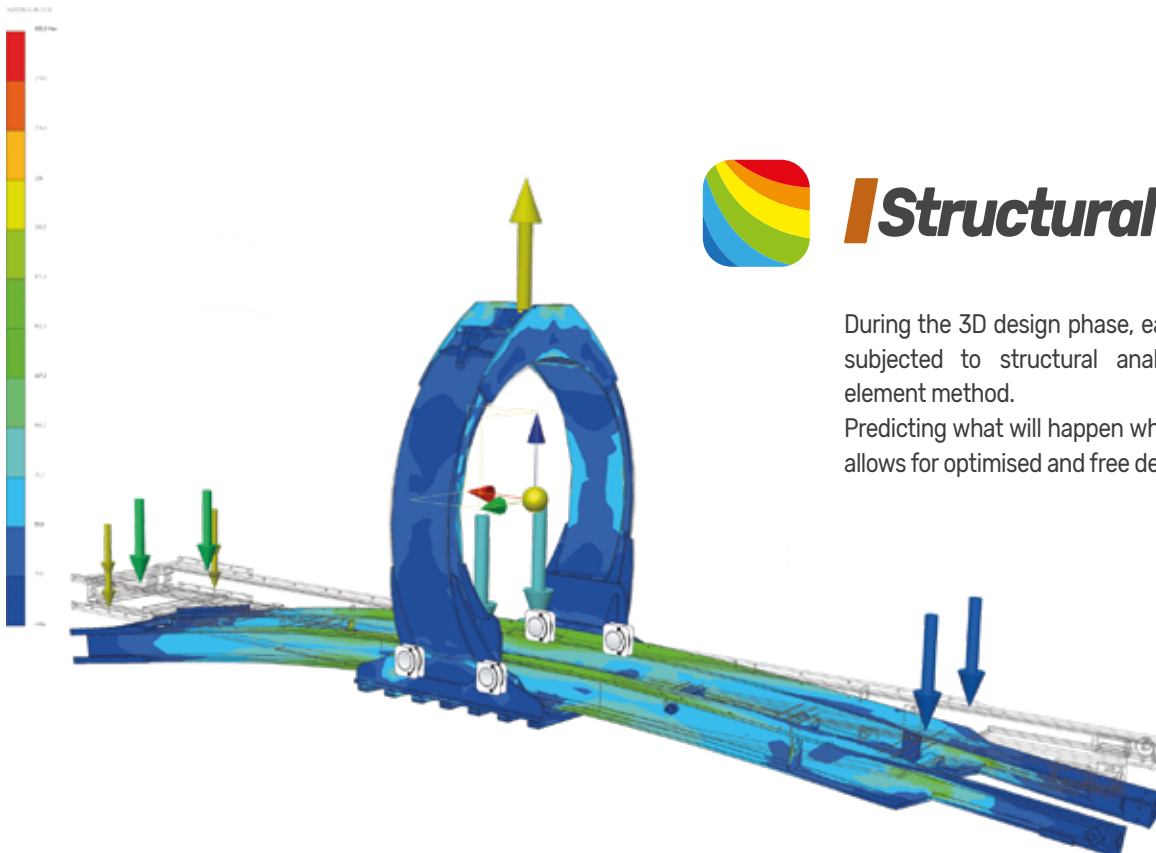
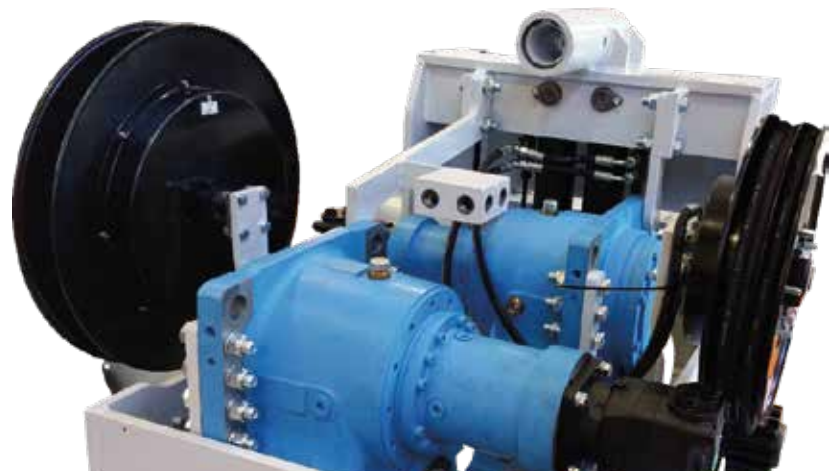

## Structural analysis

During the 3D design phase, each bundle extractor is subjected to structural analysis using the finite element method.

Predicting what will happen when the product is used allows for optimised and free design.



# Standard features of aerial tube bundle extractors

## Air-cooled diesel engine

Standard motorisation consists of an air-cooled diesel engine sized appropriately for the selected Mef express HT model.



## Spark arrestor with vibration damping

Fire and explosion protection device to limit combustion by extinguishing flames.



## Hydraulic balancing system

Two powerful hydraulic pistons allow balancing of the extractor by modifying, if necessary, the position of the frame with respect to the ring attached to the crane.



## Easy container transport

For sizes from the Mef Express HT 2545/75 up, the lifting ring can be disassembled into 3 parts to allow the extractor to be shipped in Open Top containers and help truck transportation.



## Dynanometric test of the carriage

All of our extractors are subjected to dynanometric testing to verify the actual pulling force of the carriage which will be included in the test report.



## Manual adjustment of the bundle supports

Correct support of the tube bundle is guaranteed by the support trolleys which, resting on the diaphragms, support it safely without compromising its integrity.



## Remote control with connection cable

A practical remote control with cable allows the operator to control all of the commands, whilst staying at a safe distance from the extraction area.



## Alternative lifting points

To bypass obstacles, such as nozzles, pipes or valves, which are often present on the longitudinal axis of the Mef express HT or for use with the anchor hook of the lifting crane.



## Onboard controls

All the main controls can be activated directly on the machine with hydraulic levers on the rear of the Mef express HT.



# Optional features

of overhead tube bundle extractors

## Telescopic arms for rotation of the bundle



Innovative remotely-controlled system for rotating the tube bundle which allows safe alignment the bundle with the shell, avoiding the need for the operator to climb on the Mef Express HT during the final insertion phase

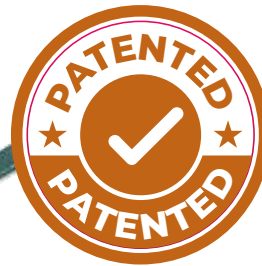

## Power-assisted hydraulic supports



Controlled quickly and intuitively by the operator from a safe distance via remote control, these speed up the extraction and insertion of the bundle with power-assisted adjustment, reducing system downtime and increasing manoeuvring capacity of the bundle during insertion





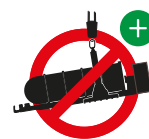

# EOC electronic overturning control

Innovative control system which allows overhead handling of loads in complete safety by inhibiting any incorrect commands that could compromise the stability of the Mef express HT.

## Main functions of the EOC system

display on the remote control screen of the real-time position of the extractor carriage corresponding to the length of the extracted ( or to be inserted ) bundle;

display on the remote control screen of the real-time inclination of the Mef express HT;

limitation of the maximum inclination with blocking of dangerous movements when the permitted inclination has been exceeded;

automatic self-balancing that can be activated by the operator via remote control which brings the Mef express HT back to a balanced condition;

electric throttle integrated into the remote control that allows variation of the engine's rpm, reducing fuel consumption, improving the extractor's autonomy and making the extraction area healthier.

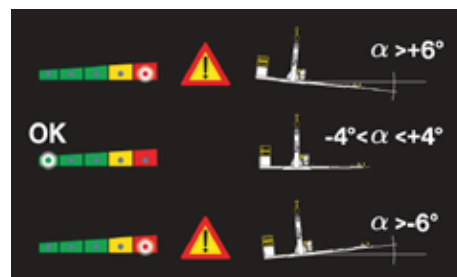

## Radio control

Evolution of the standard remote control allows the operator greater freedom of action without cluttering the work area with a connection cable

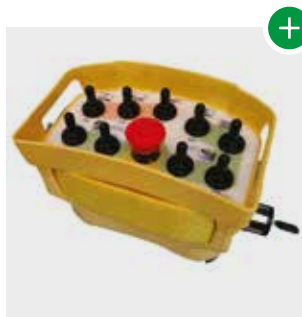

## Hydraulic trolley with manual pump

Interchangeable product on all models which use the manual version.

The manual pump simply and economically speeds up the insertion process

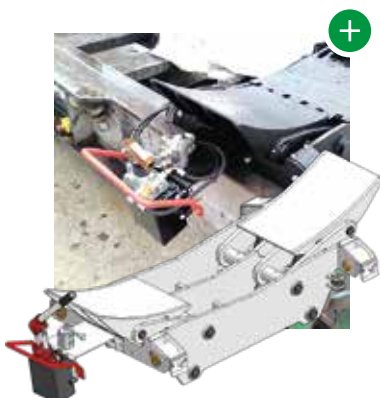

## Liquid cooled diesel engine

When air cooling is insufficient or unsuitable for current regulations, MAUS ITALIA can offer engines with low environmental impact and water cooling



## Removable extension for maximum flexibility of use



We offer an extension of 1000 mm ( 39" ) which allows the Mef express HT to increase the maximum length of the extractable bundle or to reach very recessed bundles under roofs. The extension can be customised, upon request and after technical verification, in both shape and length.

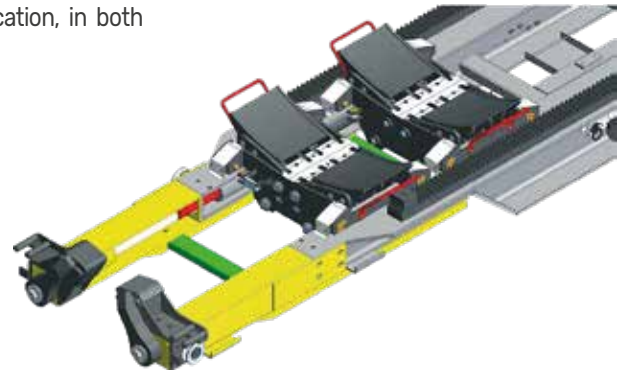

## Increased pulling force

The extraordinary pulling force offered by Maus Italia for its standard models can, if necessary, be increased for extremely heavy tube bundles.

An additional planetary gearbox increases the pulling force by over 400 kN ( 90000 lb ).





## Power-assisted hydraulic pusher

The main carriage pusher is offered with hydraulic movement to avoid potentially dangerous situations for the operator and to speed up the final insertion phase

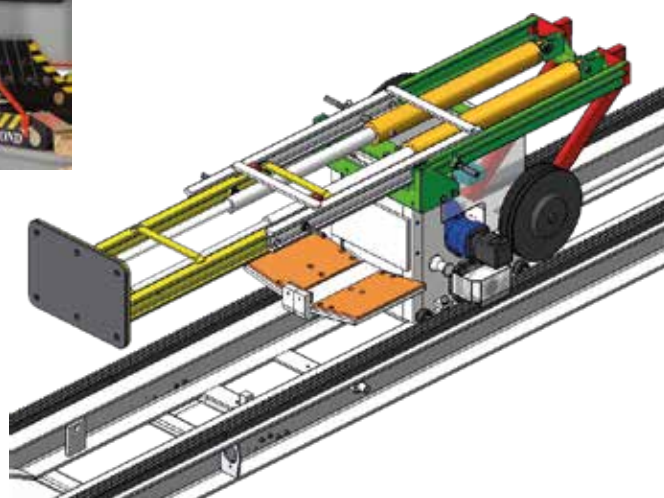

### Anchoring beam to the exchanger

When access to the back of the exchanger flange is impossible, a beam can be designed and built which, when properly fixed, recreates the anchor point.

### Adapter for the carriage shelf

If the tube sheet has a protrusion on its lower part, an adapter with a recess can be designed and built to allow it to be housed.

### Extensions for bypassing obstacles

Where there are obstacles in front of the exchanger which interfere with the extractor, extensions can be designed and built with an increased centre distance to allow them to be bypassed

# Mef Express HT ATEX Ex



## Certified manufacture of aerial tube bundle extractors

Maus Italia can, on customer request, manufacture Mef Express HT extractors in an explosion proof version, certified to operate in environments with potentially explosive atmospheres (ATEX) and on offshore/FPSO platforms (DNV - MARITIME).

### Armoured power circuits

Power circuits are insulated in explosion proof containers to prevent potential sparks from entering the work environment.



### Armoured engine components

Components such as the alternator, the starter motor and the battery are insulated in explosion proof containers to prevent potential sparks from entering the work environment.

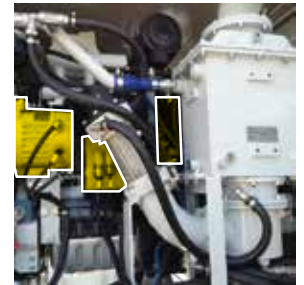

### Combustion gas cooling

The insertion of a heat exchanger and vibration damper allows the rapid cooling of exhaust gases up to the values allowed by the reference thermal class T.



### Mef Express HT

For the North American market (Canada and USA), MAUS ITALIA designs, manufactures and certifies its tube bundle extractors according to CSA reference standards.





### Overdrive control

A vacuum shutoff valve installed on the engine intake prevents the engine from overheating due to overdrive.



### Non-sparking stainless steel protections

Each sliding part is coated with stainless steel which also protects it from accumulations of grease, thus avoiding related maintenance.



The manufacture of an ATEX certified extractor is achieved by increasing its thermal and electric safety with components that have been designed to avoid, under any circumstances, the ignition of gas which may be present in the working atmosphere.



The surface temperature of the each component and of the exhaust gases must remain below the threshold defined by the reference class T.



Any possible cause of a spark must be eliminated: from electrostatic charges to insulation in armoured containers of each power circuit.

A number of the solutions adopted for manufacture of an ATEX extractor are shown on the page.



Off shore

Maus Italia can, on customer request, manufacture Mef express HT extractors in an offshore version. The DNV MARITIME certified transformation includes everything already done to obtain the ATEX certification with additional specifications for lifting accessories, movement and sizing guided by the certification specifications with a more accurate process control.



### Movement certification

Movement components, such as hydraulic cylinders and planetary gearboxes, are DNV certified for use in the open sea and in cases of extreme stress.



### Welding certification

Welds are subjected to magneticscopic (or radiographic) examination to obtain DNV certification.



### Lifting certification

Supplied chains, shackles and lifting hooks are DNV certified for use in the open sea and in cases of extreme stress.

# Optimised transport costs Shipping in container

Shipping in a crate for optional long storage

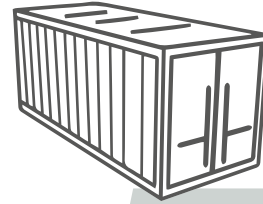

40 ft OT  
(Open Top)



Special ring divisible into 3 pieces



Mef express HT			904 70		1310 65		1722 65		1722 75		2030 75	
Ø tube sheet (max.)	D	mm inches	900	35	1300	51	1700	67	1700	67	2000	78
Bundle length (max.)	L	mm ft	7000	23	6500	21	6500	21	7500	24	7500	24
Tube bundle weight (max.)	↑	T	4	8800	10	22000	22	48500	22	48500	30	66000
Lifting capacity												



Mef express HT			904 70		1310 65		1722 65		1722 75		2030 75	
Length	L	mm ft	8000	26.2	7710	25.3	8125	26.7	9125	30.0	9125	30.0
Width	W	mm ft	1250	4.1	1590	5.2	2050	6.7	2050	6.7	2300	7.5
Height	H	mm ft	1480	4.9	2125	7.0	2600	8.5	2600	8.5	2930	9.6
Width to the engine	WM	mm ft	1300	4.3	1800	5.9	1800	5.9	1800	5.9	1800	5.9
Height to the engine	HM	mm ft	2200	7.2	2125	7.0	2250	7.4	2250	7.4	2250	7.4
Ring approach (min.)	A	mm ft	4105	13.5	3050	10.0	3310	10.9	3480	11.4	3480	11.4
Balancing ring stroke	S	mm ft	1450	4.8	1700	5.6	1700	5.6	2114	6.9	2114	6.9
Weight		Kg lb	2300	5071	4600	10141	6000	13228	6300	13889	7000	15432
Extraction speed (max.)		m/min ft/min	2,5	10.3	2,2	9.0	2,3	9.4	2,3	9.4	2,3	9.4
Extraction force (max.)	↑	kN lb	100	22400	200	44900	400	90000	400	90000	400	90000

N° of standard CS manual support trolleys

Lifting capacity of single carriage

2	2	2	2	2					
4.0	8800	15	33000	15	33000	15	33000	15	33000

# Easier truck transport

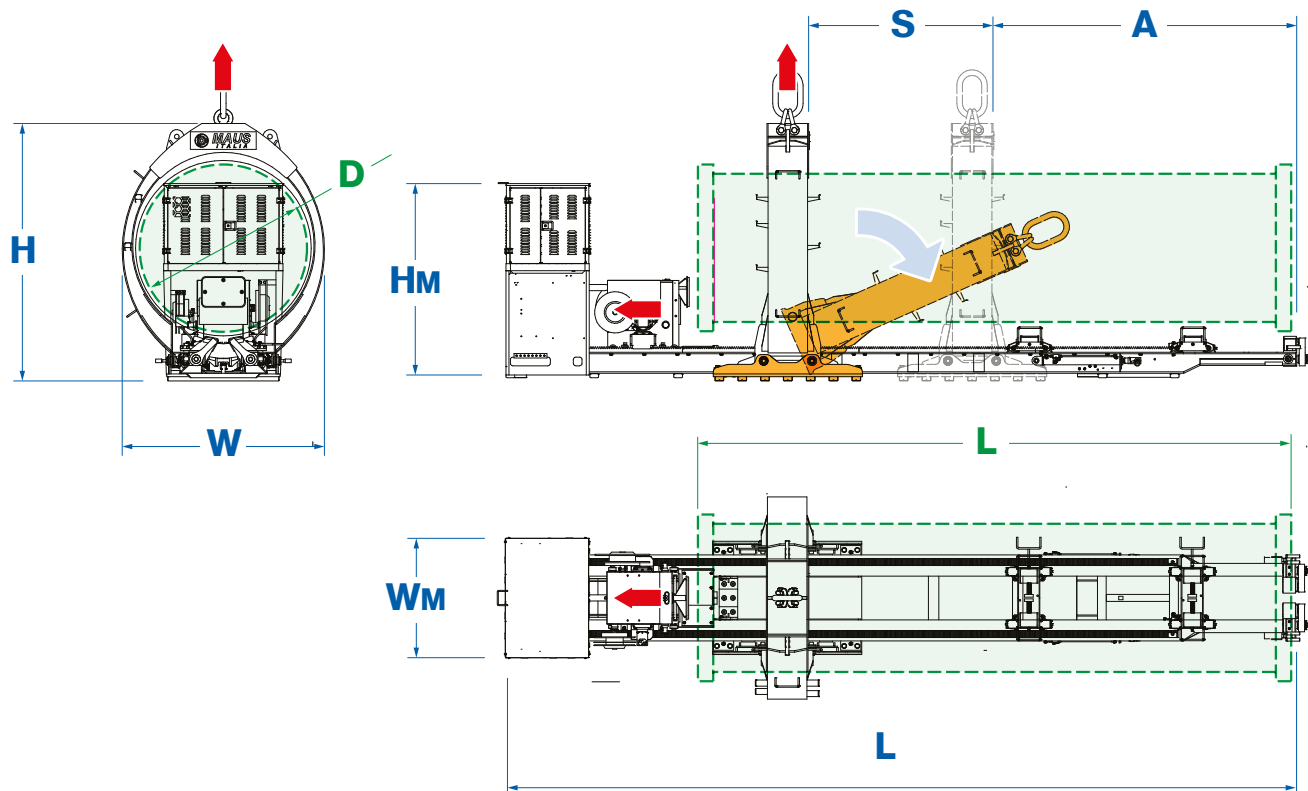

2045 75	2545 75	2545 100	3070 100	35125 113	Mef express HT
2000   78	2500   98	2500   98	3000   118	3500   138	D mm inches Ø tube sheet (max.)
7500   24	7500   24	10000   33	10000   33	11300   37	L mm ft Bundle length (max.)
45   99200	45   99200	45   99200	70   154300	125   275500	T lb Tube bundle weight (max.) Lifting capacity



2045 75	2545 75	2545 100	3070 100	35125 113	Mef express HT
9125   30.0	9125   30.0	12060   39.0	12060   39.0	13420   44.0	L mm ft Length
2300   7.5	3200   10.5	3200   10.5	3860   12.7	4300   14.1	W mm ft Width
2930   9.6	3700   12.1	3700   12.1	4370   14.3	4780   15.7	H mm ft Height
1800   5.9	1800   5.9	1800   5.9	2140   7.0	2300   7.5	Wm mm ft Width to the engine
2250   7.4	2250   7.4	2250   7.4	2250   7.4	2250   7.4	Hm mm ft Height to the engine
3510   11.5	3510   11.5	4250   13.9	4250   13.9	5695   18.7	A mm ft Ring approach (min.)
2114   6.9	2114   6.9	2750   9.0	2750   9.0	2850   9.4	S mm ft Balancing ring stroke
8600   18959	9700   21384	10900   24030	16000   35273	21000   46297	Kg lb Weight
1.3   5.3	1.3   5.3	1.0   4.1	1.0   4.1	1.0   4.1	m/min ft/min Extraction speed (max.)
520   117000	520   117000	520   117000	900   202300	1380   310200	← kN lb Extraction force (max.)
2	2	3	3	4	N° of standard CS manual support trolleys
16*   35000	16*   35000	16*   35000	30   66000	30   66000	↑ T lb Lifting capacity of single carriage
900   202300	900   202300	900   202300	1380   310200	/   /	← kN lb Extraction force (max.) Increased pulling force (optional)

**WLL**

All Mefexpress HT models offered by MAUS ITALIA are tested with a static load factor equal to 150% of the nominal capacity (**WLL** Working Load Limit)

\*Available also with 2 cylinder for lifting capacity 21T ( 46000 lb )





Extension

1000 mm (39") extensions are available for all models which allow the Mef Express HT to increase the maximum length of the loadable bundle. The extension can, upon request, be customised in both shape and length.



Customized

Maus Italia can, upon request and after technical verification, design and manufacture the Mef Express HT overhead extractor for bundles and weights which are different to the standard product.



Length

The length measurements "L" suggested above can be changed on request.



The increased pulling force request transforms some parameters of the Mef express HT :

- Length L + 400 mm (+ 1.31 ft)
- Weight + 500 kg (+ 1100 lb)

## CS support trolleys

for supporting the tube bundle during extraction/insertion with the Mef express HT series extractors.



CSM

This is the entry level model, manually controlled by the operator using removable keys. Complete in their functionality, they guarantee reliability and robustness.



CSP

This is the intermediate model, hydraulically controlled by the operator via a manual hydraulic pump installed directly on the trolley. Speeds up all lifting operations and is interchangeable with any manual models already purchased (also for the previous Mef express series)

In the event of need or of obstruction, the manual pump of the CS P support trolley can be disconnected by means of quick couplings.



CSI

This is the highest performing model, hydraulically controlled by the operator via remote control (or levers on the machine).

It significantly speeds up all lifting operations by keeping the operator at a distance from the extraction/insertion area.

Maus Italia technical staff suggest the insertion of at least one CS I trolley on each model of the Mef express HT tube bundle extractor.

The hydraulic system can manage up to two CS I trolleys.

Mef express HT	CSM	CSP	CSI	Lifting capacity ↑
Models on which the trolley works	Cod.	Cod.	Cod.	T lb
904/70	CS M-40	CS P-40	CS I-40	4,0 8800
1310/65 1722/65 1722/75 2030/75	CS M-150	CS P-150	CS I-150	15 33000
2045/75 2545/75 2545/100	CS M-160	CS P-160	CS I-160	16 35000
optional available also with 2 cylinder	CS M-210	CS P-210	CS I-210	21 46000
3070/100	CS M-300	CS P-300	CS I-300	30 66000
35125/113	CS M-300	CS P-300	CS I-300	30 66000

**1 hydraulic cylinder**  
for each saddle

**2 hydraulic cylinder**  
for each saddle

# Ideal combinations in plant maintenance

Combined use with BundleTutor series of tube bundle transporters



## BundleTutor Lifter

**Aerial transporter for the handling of tube bundles**

The Mef express HT aerial tube bundle extractor is used in combination with the Bundle Tutor lifter Super aerial transporter for handling tube bundles inside the plant. This allows you to quickly release the extractor for a new operation.

The Bundle Tutor lifter E electric plug-in model is particularly suggested for use in heat exchanger manufacturing workshops.



## BundleTutor Mobil

**Self-propelled transporter for the handling of tube bundles**

The Mef express HT overhead tube bundle extractor is used in combination with the Bundle Tutor mobil self-propelled transporter inside the plant for safe and protected handling of the tube bundle, as well as for speeding up loading and unloading without the need for a crane.









# ***BundleTutor Lifter***

*For easy, safe and secure aerial handling of the tube bundle*

# BundleTutor Lifter

*For easy, safe and secure aerial handling of the tube bundle*

Maus Italia presents the BundleTutor lifter for the aerial handling of tube bundles, for use both within the plant and during the production of heat exchangers. By lifting the tube bundle easily and safely, the BundleTutor lifter eliminates the risk of destroying the baffles and damaging the tubes.

The Maus Italia team is available to design custom solutions for extreme circumstances and ATEX / NAVY versions for the offshore market.

For independent handling using the BundleTutor mobil please refer to page 22.

**For production & onshore/offshore maintenance**



## Main features



### **Protects the tube bundle**

The BundleTutor lifter sustain and supports the tube bundle during handling using two complementary and independent feature (clamps and lifting slings), ensuring perfect support along its longitudinal axis and eliminating tensions and deformations.



### **Easy to use**

The BundleTutor lifter is an extremely easy machine to use. A small number of intuitive controls allow the easy handling of the heavy tonnage of a tube bundle.



### **Encircling**

The symmetrical clamps of the BundleTutor lifter and independent hydraulically controlled by the operator, can be easily adapted to the dimensions of the tube bundle to be lifted by encircling it carefully along its entire length.



### **Wireless - Freedom of movement**

All movement and adjustment controls can be managed by remote control on request.

## Optionals <sup>+</sup>



### **ATEX Certification**

The BundleTutor lifter can be manufactured on request according to the ATEX directive in an explosion proof configuration for use in environments with a potentially explosive atmosphere.



### **DNV certification for FPSO and o shore platforms**

Maus Italia can manufacture, on request, the offshore BundleTutor Lifter NAVY version for the aerial handling of tube bundles on FPSO and platforms DNV ST-0378 , ST-E273 - MARITIME approved.



### **Not afraid of the cold**

The BundleTutor lifter can be supplied, on request, in the special version suitable for operating at the very lowest of temperatures.



### **Adapts according to need**

Maus Italia can design, on request and after technical verification, the BundleTutor lifter for bundle measurements and weights that differ from the standard product.



# BundleTutor lifter

Aerial tube bundle transporter



ASH welded hooks for hooks or slings

Independent symmetrical clamps covered with antistatic material for supporting the bundle



## Encircling

The independent symmetrical clamps, hydraulically controlled by the operator, can be easily adapted to the dimensions of the tube bundle to be lifted by encircling it along its entire length.

## X1X2

Symmetrical opening and closing of the clamps with respect to the axis of the tube bundle to guarantee secure support and perfect centring:

Transverse opening  
**X + 600 mm (23.6")** per side.



## Coupling

In the BundleTutor lifter, the fixed coupling points are a simple and effective solution for fastening the tube bundle supporting slings. The use of a manual ratchet on the harness allows the easy securing of the tube bundle already supported by the clamps.



# BundleTutor lifter **super version**

Aerial tube bundle transporter with adjustable length

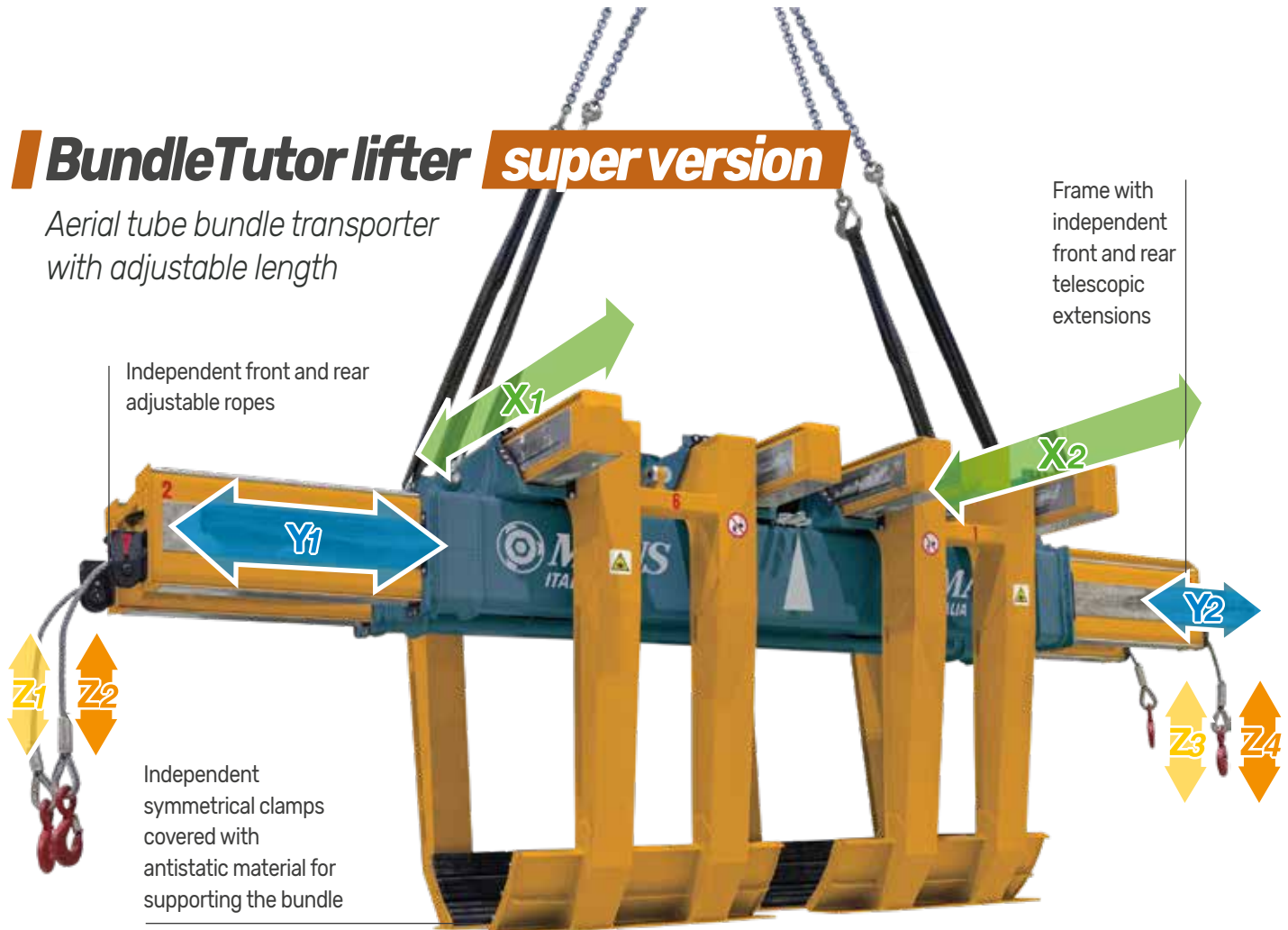

Independent front and rear adjustable ropes

Frame with independent front and rear telescopic extensions

Independent symmetrical clamps covered with antistatic material for supporting the bundle



## Encircling

The independent symmetrical clamps, hydraulically controlled by the operator, can be easily adapted to the dimensions of the tube bundle to be lifted by encircling it along its entire length.

## X1X2

Symmetrical opening and closing of the clamps with respect to the axis of the tube bundle to guarantee secure support and perfect centring:

Transverse opening  
**X + 600 mm (23.6")** per side.

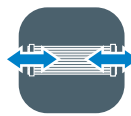

## Telescopic

Hydraulically controlled by the operator, the telescopic extensions extend the length of the most bulky of tube bundles, always ensuring perfect balance and support of the tube sheets.

## Y1Y2

Independent telescopic extensions of the longitudinal slings for protection of long tube bundles where the weight of the overhanging parts would deform the tubes:

Longitudinal extension  
**Y + 1000 mm (39.4")** front and rear.



## Compensates for errors

The control on the independent ropes, as well as improving the aligned support of the tube bundle, allows compensation ( through rotation ) for any potential positioning during setting down on the extractor.

## Z1 Z2 Z3 Z4

Independent strokes of the support ropes of the slings placed under the tube bundle facilitate precise alignment during subsequent insertion in the shell:

Vertical stroke  
**Z + 700 mm (39.4")** front and rear.

# **BundleTutor lifter *super version***

*Combined use with Mef express HT tube bundle extractor*

## **1 Alignment with extractor and approaching**

The BundleTutor lifter Super is aligned (using a crane or bridge crane) and surmounts the Mef express HT which carries the tube bundle to be moved.



## **2 Tube bundle sling and balancing**

After having adapted to the dimensions of the tube bundle, the BundleTutor lifter Super harnesses it and, extremely carefully, lifts it using the support slings controlled by independent ropes, balancing it upon the longitudinal axis; The clamps, working symmetrically, centre and encompass the bundle, ensuring its support.



## **3 Lifting and handling of the tube bundle**

The tube bundle is thus easily lifted, moved and set down in complete safety for scheduled maintenance.





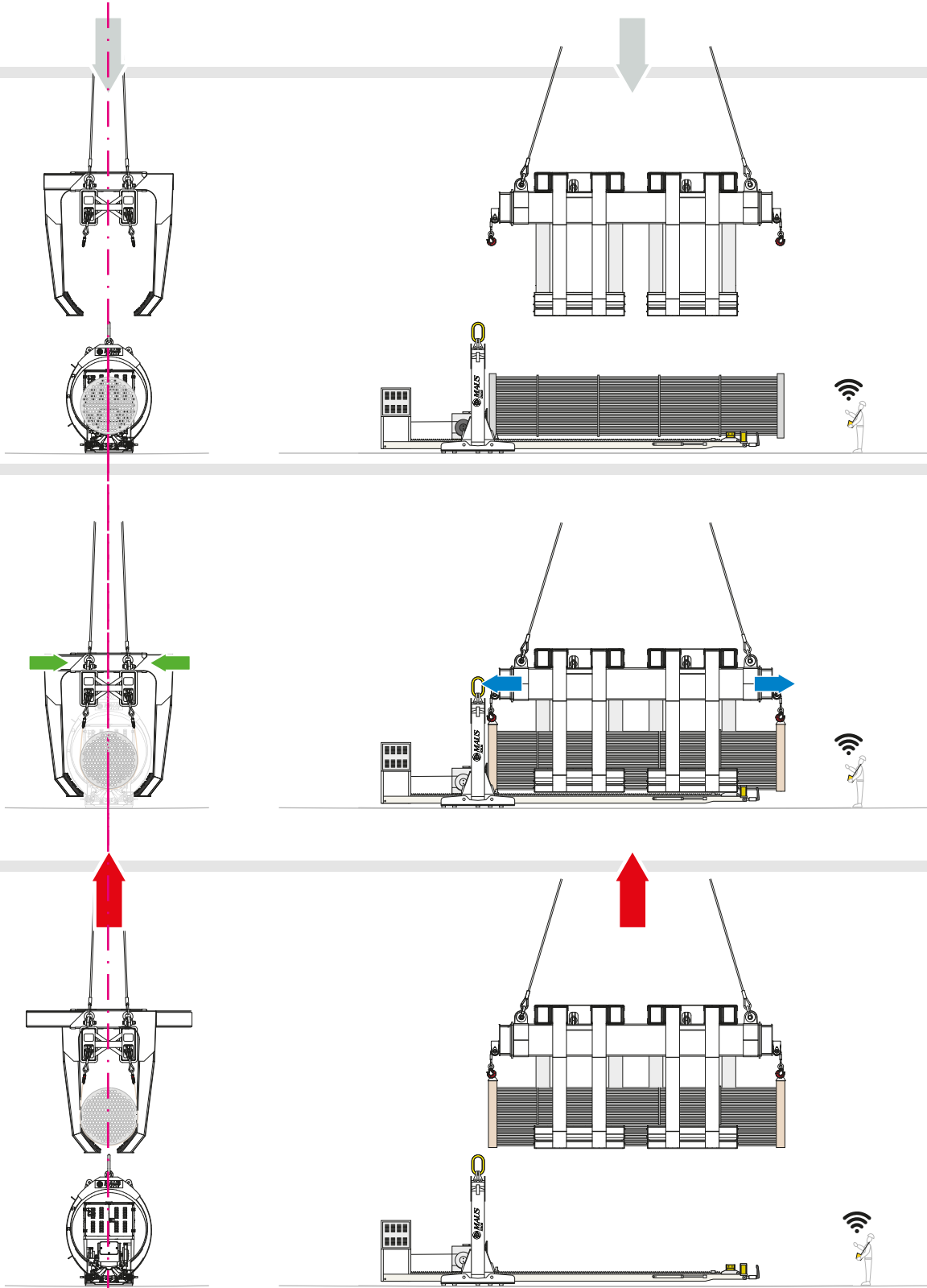

# Standard features

of our aerial tube bundle transporters



## Remote control with connection cable

Allows the operator to control all commands at a safe distance from the handling area without the often clutter connecting cable.  
( anyway supplied: 10m - 32.8ft )



## Wireless remote control

A practical remote control allows the operator to control all the commands, while remaining at a safe distance from the handling area.



## Catalytic flame arrestor with vibration damping

Fire and explosion protection device to limit combustion by extinguishing flames.



## Air-cooled diesel engine

The standard motorisation offered by Maus Italia consists of an air-cooled diesel engine.



## Structural analysis

During the 3D design phase, each BundleTutor lifter is subjected to structural analysis using the Finite Element Method. Predicting what will happen when the product is used allows for optimised and free design.

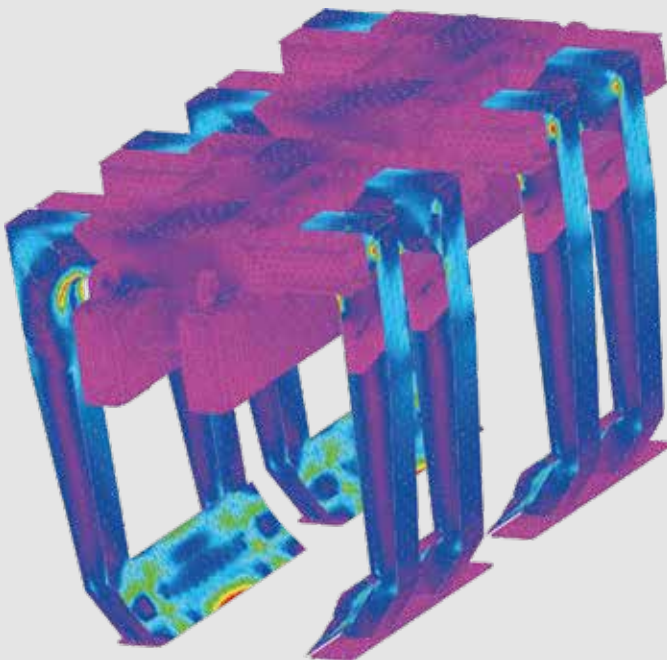

# Optional features

of our aerial tube bundle transporters



## Plug-in electric motor

For operation in closed spaces while respecting the environment and operator health, Maus Italia offer a fully electric version.

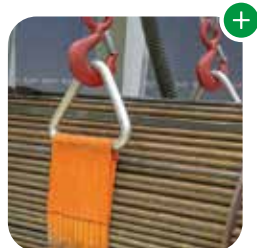

## Lifting slings

Maus Italia supplies double-layer polyester slings with a hooking system according to the BundleTutor lifter Super model and the size of the tube bundle to be handled.



## Ultrasonic sensor

The BundleTutor lifter can be equipped with 4 ultrasonic sensors to reliably detect, continuously and accurately, the distance to possible obstacles. A visual signal helps the operator at the crane or overhead crane during handling.

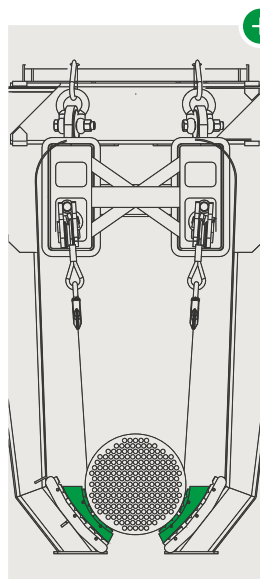
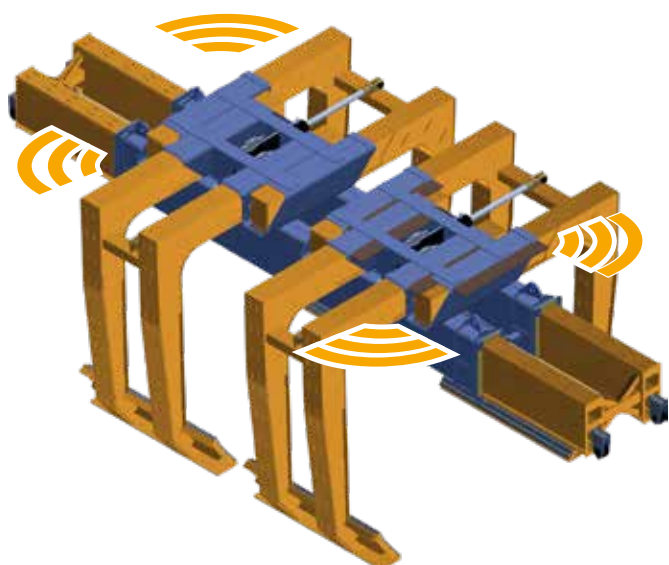

## Reducers for clamps

To improve grip on very small tube bundles, Maus Italia offers a reducer assembly coated with nitrile rubber (NBR 65) for the standard clamps. For particular size reductions, Maus Italia technical staff are available to suggest the most suitable solution and then design, build and supply the necessary components.

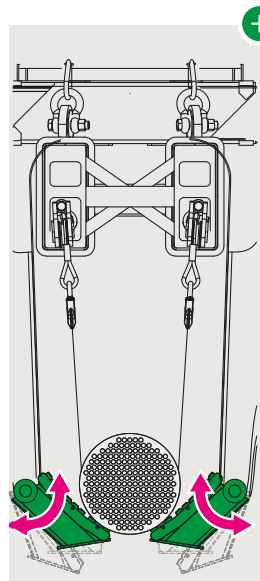

## Articulated clamps

Hydraulically assisted joints are the most efficient solution to guarantee an ergonomic grip. Additional hydraulic controls act on the joints of the clamps, adapting them to the shape of the tube bundle to be lifted.

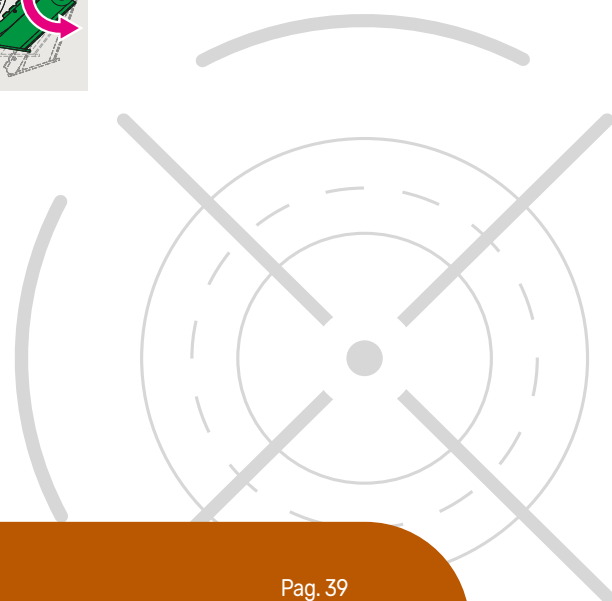



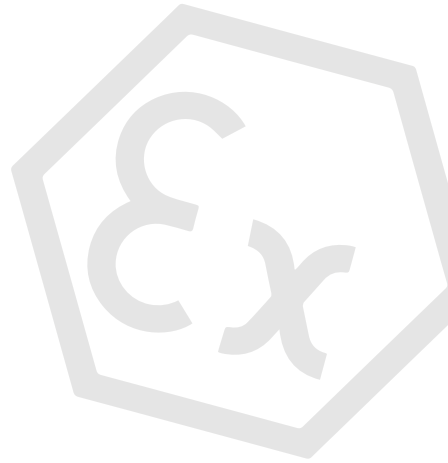

## **BundleTutor Lifter** **ATEX**

### *Certified construction of aerial tube bundle transporter*

Maus Italia, on customer request, can manufacture BundleTutor lifter in an explosion proof version, certified to operate in environments with potentially explosive atmospheres (ATEX) and on platforms/FPSO (DNV - MARITIME).

#### **Armoured engine components**

Components such as the alternator, the starter motor and the battery are insulated in explosion proof containers to prevent any sparks from entering the work environment.



#### **Armoured power circuits**

Power circuits are insulated in explosion proof containers to prevent any sparks entering the work environment.



#### **Combustion gas cooling**

Insertion of a heat exchanger and a vibration damper allows the rapid cooling of exhaust gases up to the values allowed by thermal class T.



For the North American market (Canada and USA), Maus Italia designs, manufactures and certifies tube bundle transporters according to the CSA reference standards.



### Overdrive control

A vacuum cutoff valve installed on the engine intake prevents the engine from overheating due to overdrive.



### Non-sparking stainless steel protections

Each sliding part is coated with stainless steel which also protects it from the accumulation of grease, thus avoiding any related maintenance.



The construction of an ATEX certified transporter is achieved by increasing its thermal and electric safety with components that have been designed to avoid in any way the ignition of gas which may be present in the working atmosphere.



The surface temperature of the each component and of the exhaust gases must remain below the threshold defined by the reference class T.



Any possible cause of a spark must be eliminated: from electrostatic charges to insulation in armoured containers of each power circuit.

Some of the solutions adopted for the construction of an ATEX handler are shown on this page.



# BundleTutor Lifter NAVY



*For operation in the open sea where extreme conditions and erosion are merciless*

Maus Italia patents and certifies the BundleTutor lifter, with DNV GL approval, in a special NAVY version, which it offers for the aerial handling of tube bundles on offshore platforms and FPSO.

It concentrates anti-spark materials of the highest level suitable to withstand extreme situations and for operation in potentially explosive environments (ATEX) where every possible source of ignition must be eliminated. In addition to tests simulating offshore conditions, each component and the assembled machine have been subjected to the approval of the responsible certifier.

## Extremely offshore

Equipment certified for operation in hazardous areas ATEX Zone 2, IIA/B,T3

### BTL 22 BTL 22S

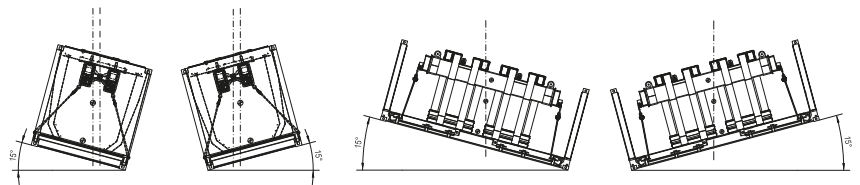

Maus Italia can manufacture, on customer request, offshore BundleTutor lifter handlers.

The DNV MARITIME certified transformation includes everything which has already been done to obtain ATEX certification with additional specifications for lifting accessories, movement and sizing guided by certification with more accurate process control.

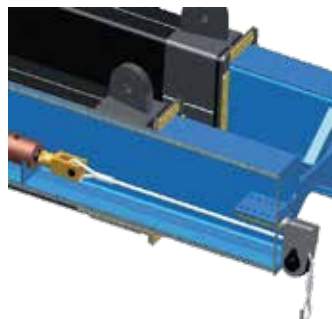

### Movement certification

Movement components, such as hydraulic cylinders and planetary gearboxes, are DNV certified for use in the open sea and in cases of extreme stress.



### Welding certification

Welds are subjected to magnetoscopic (or radiographic) examination to obtain DNV certification.



### Lifting certification

The supplied chains, shackles and lifting hooks are DNV certified for use on platforms and in cases of extreme stress.



# BundleTutor Lifter E



*For operation in closed spaces while respecting the environment and operator health*

Maus Italia offers a **fully electric version** of the BundleTutor lifter, especially for workshops and closed spaces where the use of a combustion engine causes an unhealthy environment.

The BundleTutor Lifter E is offered as a green solution with **zero emissions** and with autonomy of **over 25 working cycles**.



*7h of charging for 25 working cycles in full autonomy*



The reference diameter for gripping the tube bundles is that of the diaphragms, significantly lower than that of the relative tube sheet

## BundleTutor lifter

<b>BundleTutor Lifter</b>				<b>BTL 30</b>	
Lifting capacity (max.)	↑	T	lb	30	66000
Ø bundle baffes (min.)	d	mm	inches	600	23,6
Ø bundle baffes (max.)	D	mm	inches	1800	70,9
Length	A	mm	ft	4100	13.5
Width	B	mm	ft	3040	9.8
Width (closed)	BC	mm	ft	2060	6.8
Height	C	mm	ft	2300	7.6
Weight		T	lb	5,2	11470



**BTL 22**

## BundleTutor lifter **super version**

<b>BundleTutor Lifter super version</b>				<b>BTL 30S</b>	
Lifting capacity (max.)	↑	T	lb	30	66000
Ø bundle baffes (min.)	d	mm	inches	600	23,6
Ø bundle baffes (max.)	D	mm	inches	1800	70,9
Length	A	mm	ft	6580	21.6
Length(closed)	AC	mm	ft	4580	15.0
Width	B	mm	ft	3040	9.8
Width (closed)	BC	mm	ft	2060	6.8
Height	C	mm	ft	2300	7.6
Weight		T	lb	6,5	14330



### Customized

Maus Italia can design, on request and after technical verification, the BundleTutor lifter with diesel or electric motorisation for bundle measurements and weights that differ from the standard product.

## BundleTutor lifter

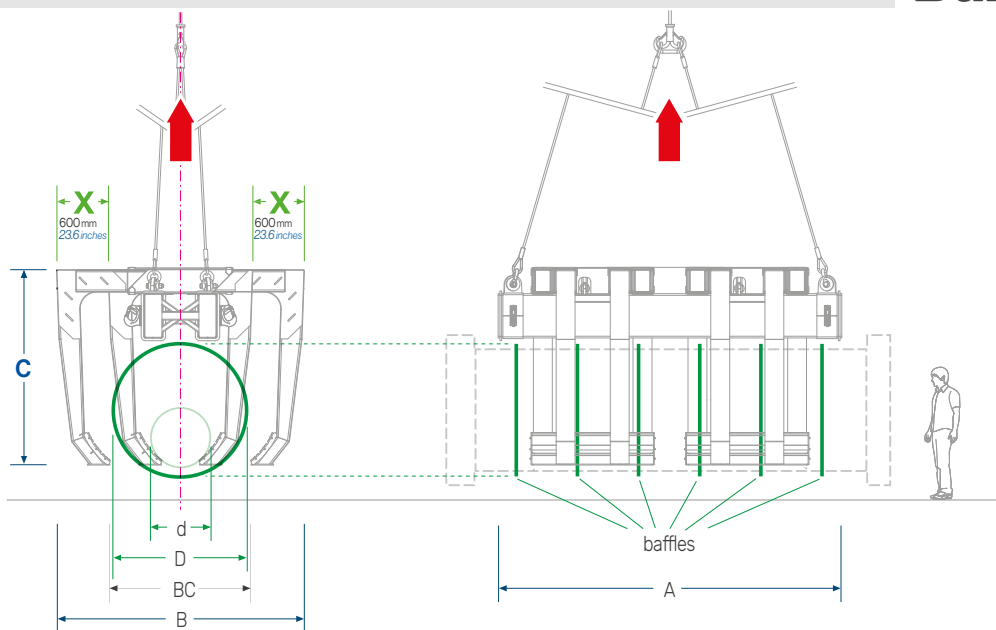

## BundleTutor lifter **super version**

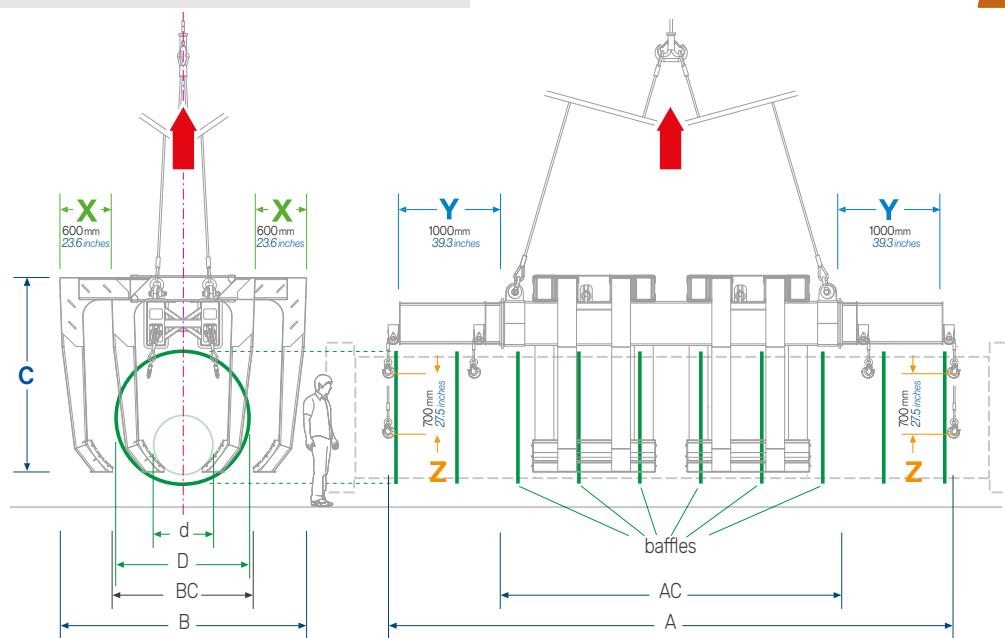



## Motorisation of aerial tube bundle transporters

Maus Italia offers the engines listed below for its diesel and electric versions. Different engines are available upon request to meet the requirements of the country where the BundleTutor lifter will operate or for particular required emissions certificates.

<b>Motorisation</b>				<b>BundleTutor Lifter D</b>	
Model	YANMAR L100V6 *				
Type	4 stroke - air cooled				
Suction	Natural				
Combustion system	Direct Injection				
Cylinders	1				
Displacement	l	<b>inches<sup>3</sup></b>	0,435	<b>26.5</b>	
Nominal power (@ 3600 rpm)	kW	<b>HP</b>	6,8	<b>9.1</b>	
Fuel Oil Tank Capacity	l	<b>US Gal</b>	5,4	<b>1.43</b>	
Fuel consumption (full load - continuous use)	l/h	<b>US Gal/h</b>	0,9	<b>0.24</b>	



\* or equivalent

<b>Motorisation</b>				<b>BundleTutor Lifter E</b>	
Engine performance with S2 (ED)	kW		4,0		
Electrolyte	Sulfur acid thixotropic gel				
Battery voltage/rated battery capacity	V/Ah	<b>V/Ah</b>	6/198	<b>6/198</b>	
Number of batteries			8	<b>8</b>	
Battery weight	Kg	<b>lb</b>	31	<b>69</b>	
Charging time from discharge	h	<b>h</b>	7	<b>7</b>	
Optional charging station	Fixed position / On-board				









mausitalia.it

BOVERI Tc 40/3



# ***BundleTutor Mobil***

*For the quick, safe and secure independent handling of the tube bundle*

# BundleTutor Mobil

*For the quick, safe and secure independent handling of the tube bundle*

Maus Italia offers the BundleTutor mobil for the handling of tube bundles independently of cranes and trucks inside the plant, speeding up loading and unloading of Mef express HT bundle extractors and transportation from the extraction point to the washing area or maintenance workshop.

The Maus Italia team is available to design custom solutions to provide solutions for extreme cases and ATEX explosion proof and NAVY versions for the offshore market.

**For maintenance**



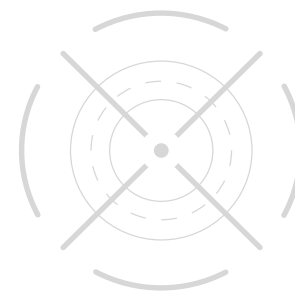

# Main features



## Total protection of the bundle

The BundleTutor mobil sustain and supports the tube bundle during handling using two complementary and independent feature ( clamps and lifting slings ), ensuring perfect support along its longitudinal axis and eliminating tensions, and deformations.



## Compensates for errors

The BundleTutor mobil, thanks to its independent adjustable ropes, compensate (through the rotation of the tube bundle) for any potential positioning errors during setting down on the extractor. This facilitates its subsequent insertion into the shell of the heat exchanger.



## Nimble

The BundleTutor mobil is an evolved 4x4 with front/rear driving and steering wheels that allow extremely small turning circles and rapid positioning. Independent shock absorbers also allow it to compensate for unevenness in the road surface.



## No crane/truck - Independent

Neither trucks nor cranes are required for handling the tube bundle inside the plant for loading and unloading.



## Wireless - Freedom of movement

All movement and adjustment commands are managed by remote control.

## Optionals



## Adapts according to need

Maus Italia can, on request and after technical verification, design the BundleTutor mobil for bundles with measurements and weights different from its standard product.



## ATEX certification

The BundleTutor mobil can be manufactured, on request, according to the ATEX directive in an explosion proof configuration for use in environment with a potentially explosive atmosphere.



## Not afraid of the cold

The BundleTutor mobil can, on request, be supplied in the special version suitable for operating at the very lowest of temperatures.





### Compensates for errors

The control on the independent ropes, as well as improving the aligned support of the tube bundle, also allows compensation ( through rotation ) for any potential positioning errors during setting down of the extractor.

### Z1 Z2 Z3 Z4

Independent strokes of the support ropes of the slings placed under the tube bundle facilitate precise alignment during subsequent insertion in the shell:

Vertical stroke

**Z +700 mm (39.4")** front and rear.



# BundleTutor Mobil

Combined use with the Mef express HT tube bundle extractor

Each component is designed in 3D and tested in a virtual environment before being produced

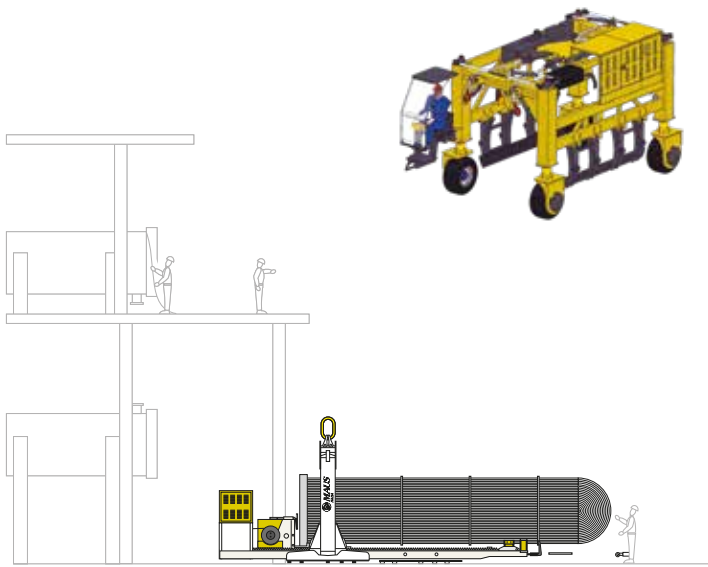

The BundleTutor mobil is used for the handling of tube bundles inside the plant in combination with a Maus Italia tube bundle extractor from the Mef express HT series.

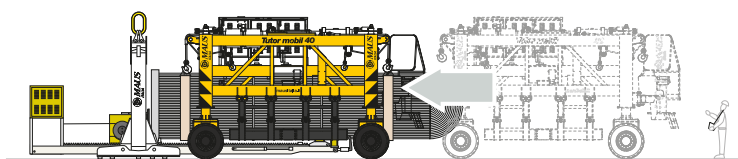

**Alignment with the extractor and approaching**

**1**

The BundleTutor mobil aligns easily ( thanks to the 4 driving and steering wheels ) and surmounts the Mef express HT which carries the tube bundle which has just been extracted;

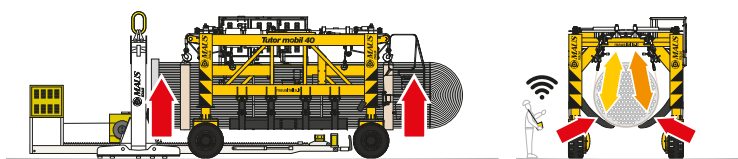

**Harnessing of the tube bundle and balancing**

**2**

Using the support slings which are controlled by independent ropes, the BundleTutor mobil harnesses the tube bundle and lifts it with extreme care. Working symmetrically, the clamps centre and encircle the bundle, ensuring that it is balanced along its longitudinal axis;

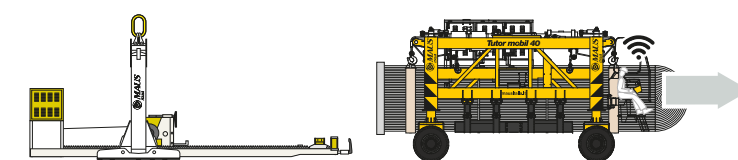

**Lifting and handling of the tube bundle**

**3**

The tube bundle is transported and unloaded at its destination inside the plant in complete safety for scheduled maintenance without the use of trucks or cranes.

## **Standard features**

*of independent tube bundle transporters*



### **Air-cooled diesel engine**

The standard engine consists of an air-cooled diesel engine sized to fit the proposed BundleTutor mobil model.



### **Cushioning system**

Each of the BundleTutor mobil 's wheels has an independent cushioning system to ensure the stability of the load during moving on uneven surfaces.



### **Catalytic flame arrestor with vibration damping**

Fire and explosion protection device to limit combustion by extinguishing flames.



### **Removable driving seat with remote control housing**

Using the wireless remote control, the operator can choose whether to sit comfortably in the driver's seat or accompany the BundleTutor mobil at a distance.



### **Very short tube bundles**

Four deflection pulleys facilitate the loading of shorter tube bundles by moving longitudinally, within the BundleTutor mobil, the descent point of the independent harnessing cables.



### **To see better and to be noticed**

The BundleTutor mobil is equipped with 4 LED headlights for front and rear lighting and 2 warning lights.





# Optional features

of independent tube bundle transporters



## Liquid-cooled diesel engine

When air-cooling is insufficient or unsuitable for current regulations, Maus Italia can offer engines with low environmental impact and liquid cooling.



## Lifting slings

Maus Italia supplies double-layer polyester slings with a hooking system suitable for the BundleTutor mobil model and the size of the tube bundle to be handled. For special circumstances, the Maus Italia technical staff are available to customers to suggest the most suitable solution and to provide the necessary material.



## Articulated clamps

Joints are a very efficient solution for guaranteeing an ergonomic grip. The clamps, thanks to their articulated joints, adapt to the shape of the tube bundle to be handled.



# Technical features

of independent tube bundle transporters



## Nimble Extremely small turning circles

Particular attention has been paid to the agility of the BundleTutor mobil which, with 4-wheel drive and steering, is able to navigate the journey within the plant.

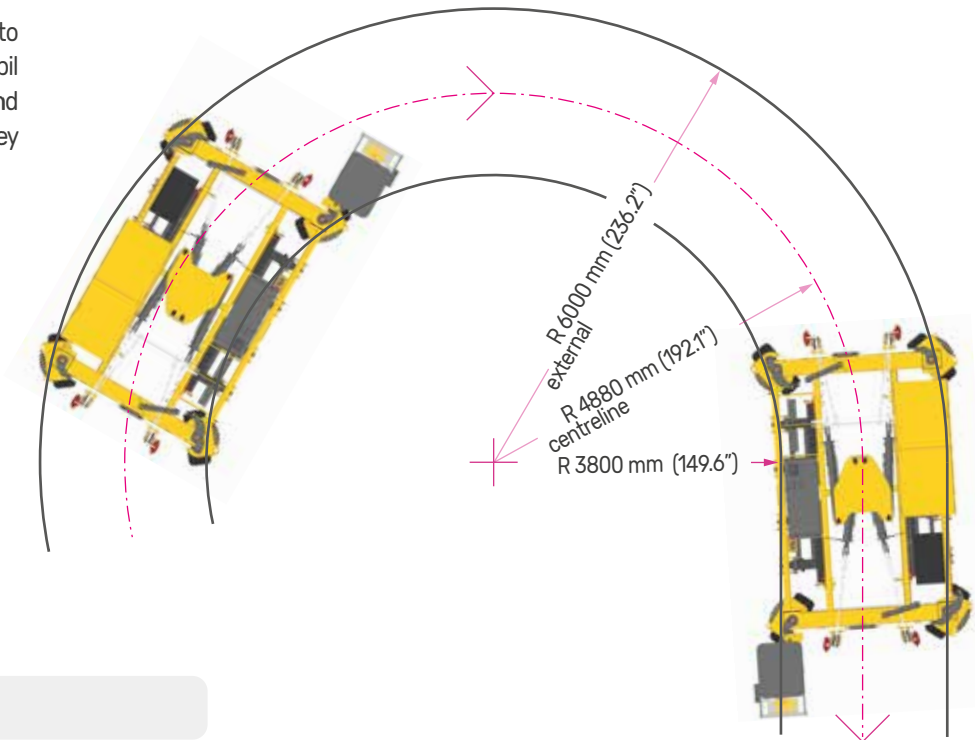
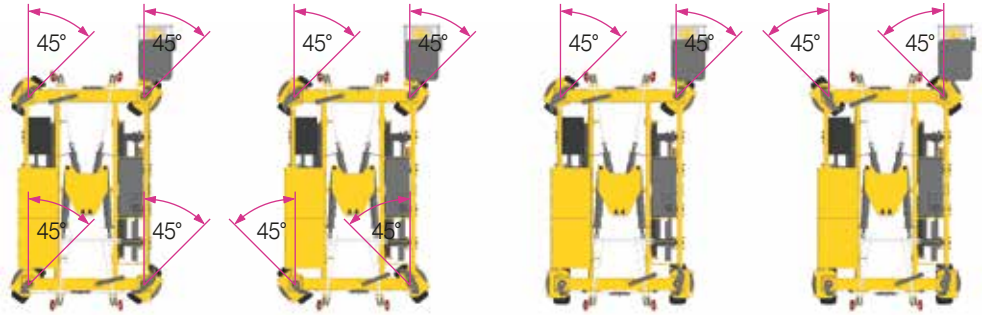

## Wireless

### Remote control commands

- Front driving and steering
- Speed regulation
- Front lift
- Rear lift
- Rear steering
- Horn
- Emergency
- Engine speed
- Opening and closing of the bundle support clamps
- Receiver connection activation
- Engine start and stop



# Technical features

of independent tube bundle transporters

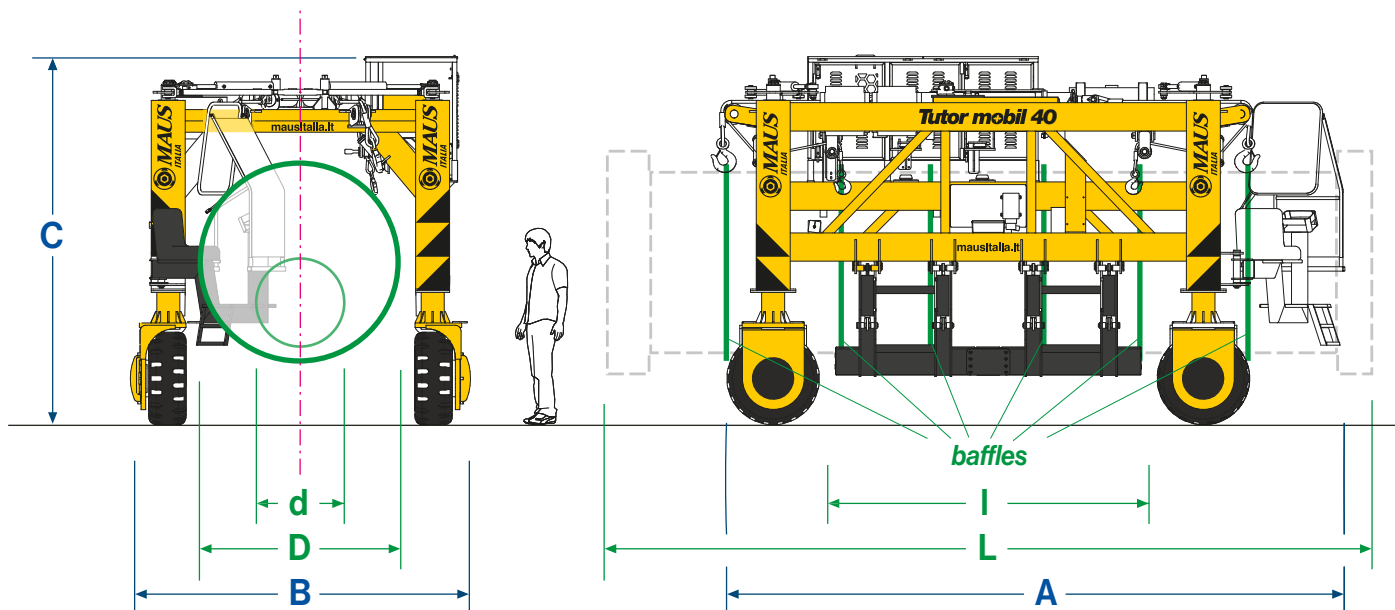

## Working capacity

				BundleTutor Mobil	
Ø bundle baffles (min.)	d	mm	inches	400	15.7
Ø bundle baffles (max.)	D	mm	inches	2000	78.7
Bundle length (min.)	I	mm	inches	/	/
Bundle length (max.)	L	mm	inches	7500	295.3
Lifting capacity (max.)	T	lb		40	88000
Speed with no load (max.)		km/h	mph	7	4.3
Speed at full load (max.)	R	km/h	mph	4	2.5
Minimum turning radius		mm	inches	3800	149.6
4 wheel steering (max.)				+/- 45°	+/- 45°
Negotiable slope (max.)				10%	10%

## BundleTutor Mobil

## Dimensions

	BundleTutor Mobil		
Length	A	mm ft	5490 18.0
Width	B	mm ft	2720 8.9
Height	C	mm ft	3260 10.7
Weight	T	lb	8,5 18700

## Motorisation

## BundleTutor Mobil

Model	JOHN DEERE - PowerTech™ PWL 4.5L Engine *			
Suction	Aftercooler air-air			
Combustion system	Direct Injection			
Cylinders	4			
Displacement	l	inches <sup>3</sup>	4,5	275
Nominal power	kW	HP	93	125
Noise @ 1m	dB(A)	dB(A)	92,5	92,5
Emissions certifications	CARB EPA Tier 4 EU Stage IV			

\* or equivalent







# *Mef Mobil*

*Self-propelled tube bundle puller ( on-shore ) for the extraction and transportation of tube bundles*

# Mef Mobil

## Self-propelled tube bundle puller ( on-shore ) for the extraction and transportation of tube bundles

The Mef Mobil, self-propelled tube bundle puller, is designed for areas which are difficult to access with cranes for the extraction and transportation of tube bundles.

The Mef Mobil operates autonomously without the need for cranes and trucks for extraction and transportation of the tube bundle to the maintenance area.

Up to 5850 mm ( 230" ) Height

Max weight up to 20 Tons.



Solution for difficult access areas



ATEX Certification on request



Special model for low temperature is available on request

-  Bundle elevation
-  Longitudinal frame movement
-  Lateral frame translation

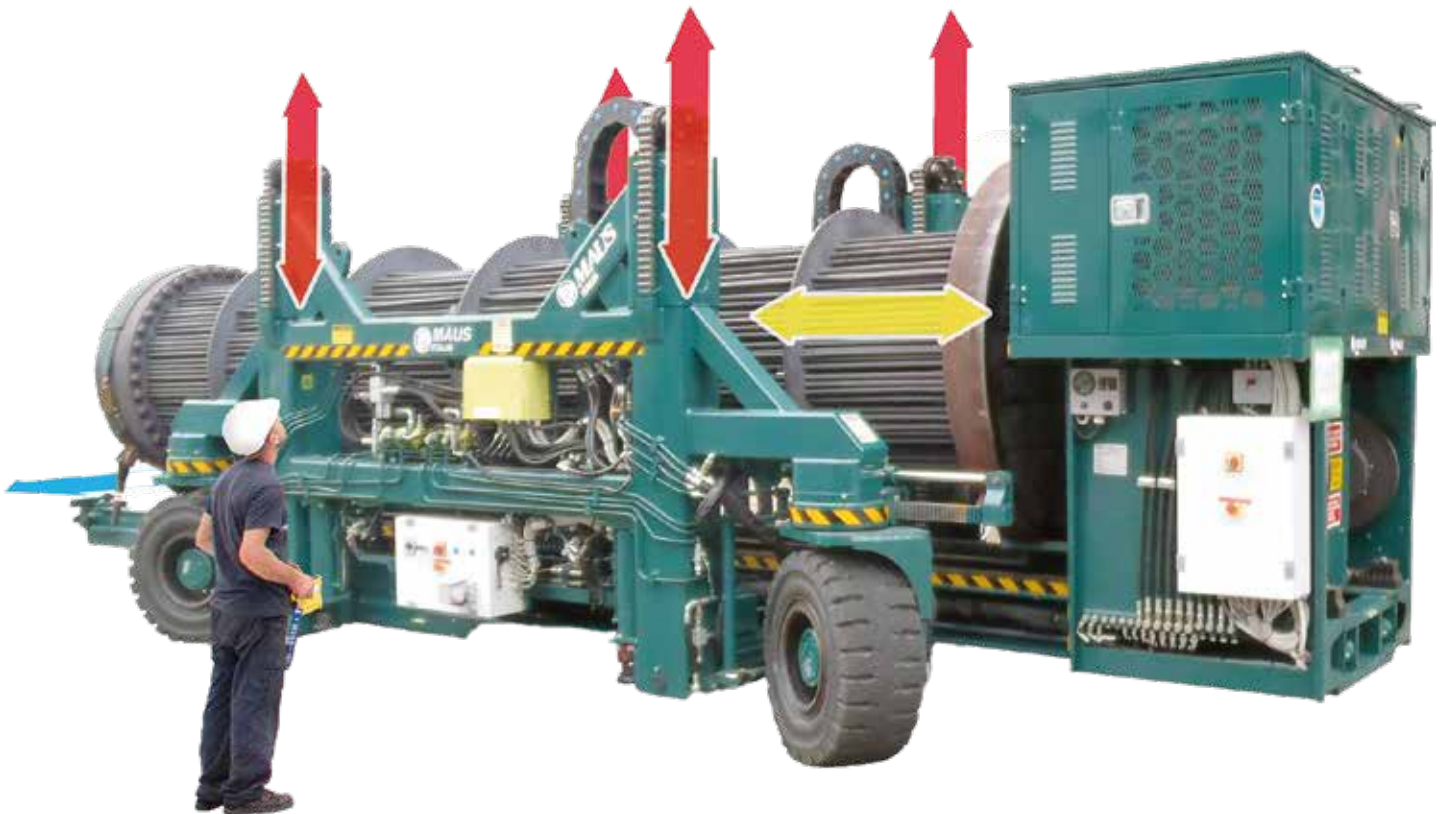



**Bundles dimensions and Max weight**

Tubesheet O.D.	mm inches	1650÷1800	65÷70
Length	mm inches	6500	256
Max lifting capacity	T Lb	20	44000

**Performance / working capacities**

Bundle elev. (min)	mm inches	600	24
Bundle elev. (max)	mm inches	4000÷5850	158÷230
Pulling max speed	m/min Ft/min	2,0	6.6
Pulling / Pushing force	T Lb	30	66100

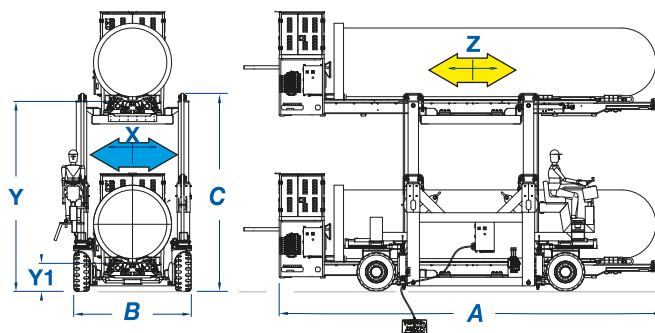

**Overall dimensions and weight**

Length	A	mm Ft	8105	26.6
Width	B	mm Ft	2500	8.2
Height	C	mm Ft	4182	13.72
Laterally frame translation	X	mm inches	±100	±3.94
Longitudinal frame movement	Z	mm inches	±750	±29.53
Weight		T Lb	12	26500

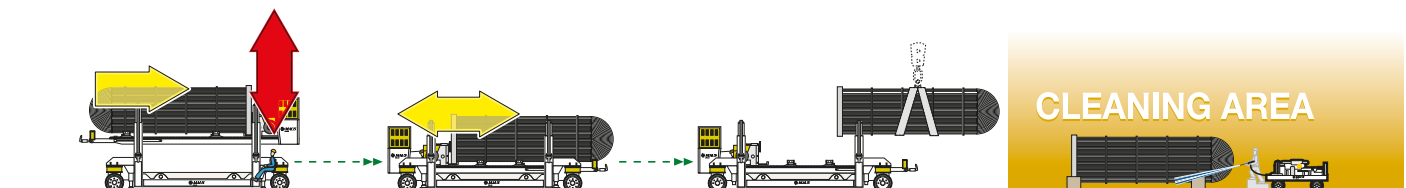

# Mef Mobil NAVY



**Self-positioning tube bundle puller, remote controlled for extraction, hoisting and movement of tube bundles (off-shore)**

Self-positioning tube bundle extractor Mef Mobil NAVY, suitable for ocean platforms and FPSO installations. This is a special model of the Mef Mobil, designed and manufactured to meet the specific demands for safety and off-shore manoeuvrability.

**Mef Mobil NAVY is designed to be operated in hazardous areas classified**







# MefTT 23

*Completely independent tube bundle puller for onboard truck assembly*



# Mef TT 23

## Completely independent tube bundle puller for onboard truck assembly

The Mef TT 23 model tube bundle puller is designed to be mounted easily on the truck for the extraction of the tube bundle without the use of a crane. This system is particularly advised for maintenance companies who constantly operate in the petrochemical plant field.

- **Lifting capacity up to 23 Tons**
- **Lifting of the tube bundle**  
from 600mm to 7000 mm ( from 24" to 275" ) height
- **Lateral translation of extraction frame +/- 100 mm ( +/- 4" )**  
Hydraulic device for centring the Mef TT 23 in relation to the heat exchanger without the need for repositioning
- **Longitudinal movement of the extraction frame**  
to increase the flexibility of the TT 23
- **Bidirectional carriage**  
Ability to extract / insert the tube bundle on both sides without turning the truck
- **Slewing ring**  
for rotating the whole lifting device ( rotation stroke up to 100° )

Up to 7000mm ( 275" ) height

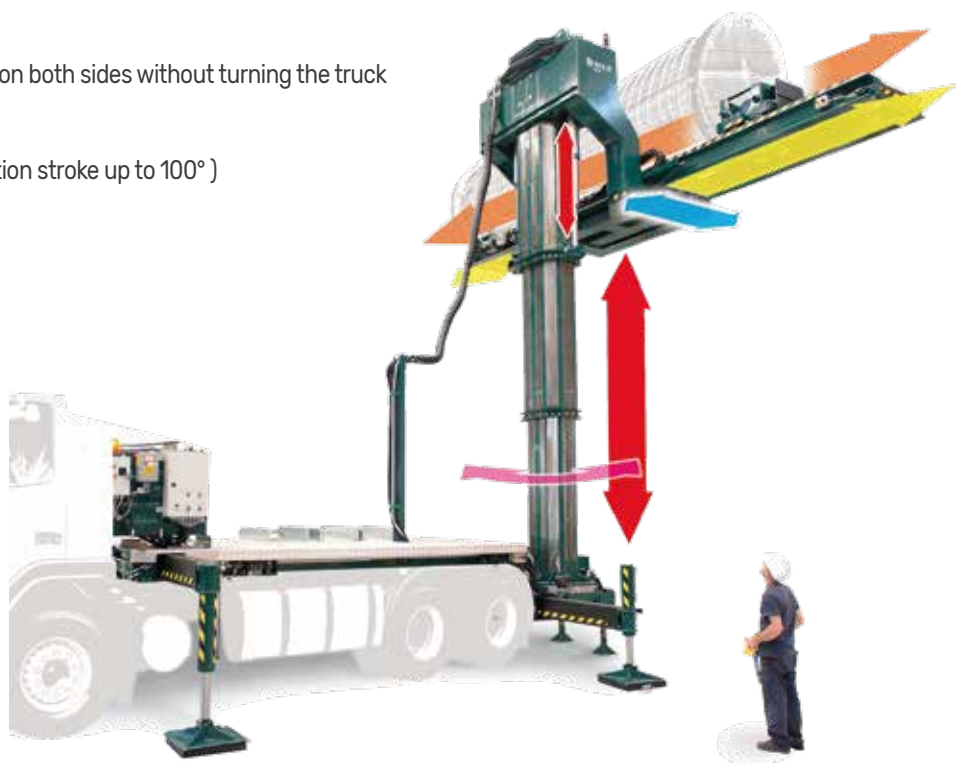

### EOC Anti-roll electronic control

The Mef TT 23 has an innovative system which allows loads to be moved in complete safety by inhibiting any incorrect commands that would compromise safety, ensuring compliance with requirements for CE certification.

## Assembling on the truck

In order to facilitate the homologation and registration procedure at the end-user country, the bundle puller Mef TT 23, manufactured by Maus Italia can be locally assembled on the truck provided by the customer ( previous suitability verification with the project requirements ), by a specialized local company.



### Overall dimensions and weight

Length	<b>A</b>	mm	Ft	7627	25.02
Truck Width	<b>B</b>	mm	Ft	2495	8.18
Height	<b>C</b>	mm	Ft	3950	12.96
Weight		T	Lb	15,5	34170
Dead weight		T	Lb	4,5	9920

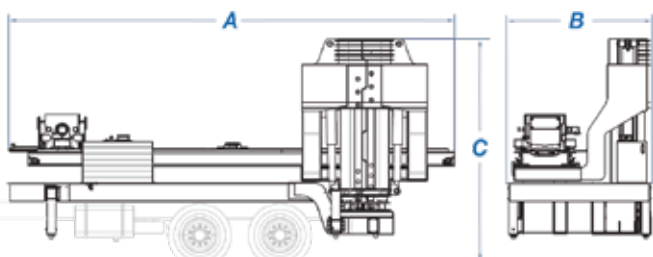

### Bundles dimensions and Max weight

Tubesheet O.D.	mm	inches	2000	78.74
Length	mm	inches	8000	314.96
Max lifting capacity	T	Lb	23	50700

### Performance / working capacities

Bundle elev. (min/max)	mm	inches	600/7000	24/275
Pulling max speed	m/min	Ft/min	2,5	8.2
Pulling / Pushing force	T	Lb	50	110200

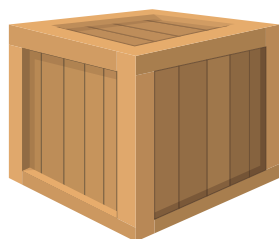

## Shipment

The bundle puller Mef TT 23, due to the overall dimension of the machine closed in recovered position, can be packed, fully assembled and ready to be installed on the truck frame, in one wooden box for an easy shipment all over the world.







# *Mef Fixed NAVY*

*Fixed tube bundle puller, remote controlled for extraction of tube bundles (off-shore)*

# Mef Fixed NAVY



## Fixed tube bundle puller, remote controlled for extraction of tube bundles (off-shore)

The Mef fixed NAVY is a simplified stationary model of the Mef mobil to meet the demands of tube bundle extraction on board oil rigs, oceanic petroleum plants and plants on board FPSO vessels.

Mef fixed NAVY fixed tube bundle extractor, suitable for ocean platforms and FPSO installations. This is a simplified version of the Mef mobil NAVY designed and manufactured to meet the specific demands for safety and off-shore manoeuvrability.

- **Mef fixed NAVY is designed to be operated in hazardous areas classified**
- **Mef fixed NAVY 1500156-E CSA model classified area Class 1 - Zone 1 - IIBT3**

Customized

 ATEX Certification



### Separate motor and control unit

In order to reduce the dimensions and weight of the Mef fixed NAVY, the engine and the hydraulic unit are assembled in a separate unit.







# ***HDS Hardscal***

*Mechanical internal cleaning with rigid shafts for heat exchanger tubes*

# HDS Hardscal

*Mechanical internal cleaning with rigid shafts for heat exchanger tubes*

The pneumatic cleaners with modular rigid shafts and water cooling of the tool, are the simplest and most effective solution for cleaning double sheet heat exchanger tubes, even if they are completely obstructed.

By selecting the appropriate model of cleaning tool according to the characteristics of the residue inside the tubes, you guarantee a deep clean. The continuous flow of running water through the drainage holes in the tools, with a maximum pressure of 20 Bars ( 290 psi ), provides cooling during operation as well as providing drainage of the removed material.



## **Your first choice**



**Handy**

It weighs less than 5 kg



**Practical**

Simple to use





## Standard supply

- > Air hose 1/2" - Length 6m ( 19.7 fts )
- > Water hose 3/8" - Length 6m ( 19.7 fts )
- > Muffler
- > Additional handle
- > Water handle valve
- > Air lubricator
- > Set of spare vanes
- > Operating handbook



## Hardscal versions

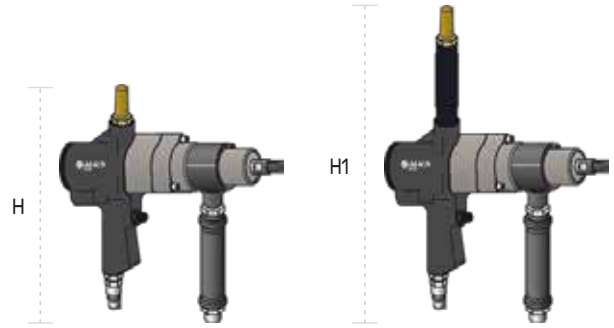

### Hardscal

### HDS3200

### HDS950

R.p.m			3200	3200	950	950
Tube O.D. (from + to)	mm	"	9,5 ÷ 25,4	3/8" - 1"	9,5 ÷ 63,5	3/8" ÷ 2.1/2"
Dimensions LxDxH/H1	mm	"	242 x 66 x 300/400	9,5" x 2,6" x 11,8"/15,8"	277 x 66 x 300/400	10,9" x 2,6" x 11,8"/15,8"
Weight	Kg	Lb	3,5	7.8	4,5	10
Pressure	Bar	Psi	6-7	90-100	6-7	90-100
Air consumption	Lt/min	Cfm	840	30	840	30

## Technical specifications

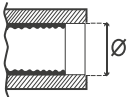
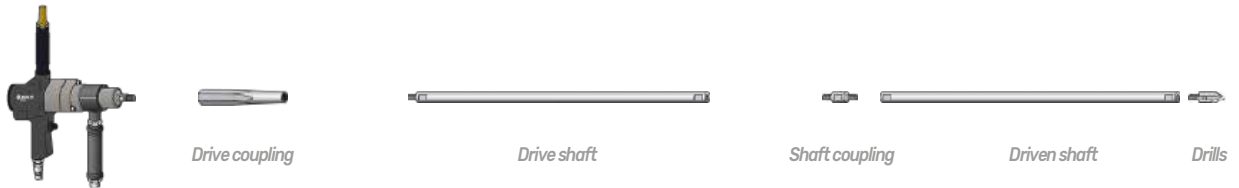

### Drive coupling

### Drive shaft

### Shaft coupling

### Driven shaft

mm	inches	Model	Thread	Model	mm	inches	Thread	Model	Thread	Model	Thread
7,39 ÷ 9,09	0.291 ÷ 0.358	<b>MAT-337-A</b>	5/8" NF x 1/4" NF	<b>MCC-336</b>	6,35	1/4	1/4" NF x 10-32 F	<b>MCC-334</b>	10-32 M	<b>MCC-335</b>	10-32 F x 10-32 F
9,09 ÷ 10,67	0.359 ÷ 0.335	<b>MAT-333-A</b>	5/8" NF x 5/16" NF	<b>MCC-332</b>	7,94	5/16	5/16" NF x 1/4" NFF	<b>MCC-330</b>	1/4" NFM	<b>MCC-331</b>	1/4" NFF x 1/4" NFF
10,67 ÷ 12,27	0.421 ÷ 0.483	<b>MAT-321-A</b>	5/8" NF x 3/8" NF	<b>MCC-324</b>	9,52	3/8	3/8" NF x 1/4" NFF	<b>MCC-322</b>	1/4" NFM	<b>MCC-323</b>	1/4" NFF x 1/4" NFF
12,27 ÷ 15,44	0.484 ÷ 0.608	<b>MAT-313-A</b>	5/8" NF x 7/16" NF	<b>MCC-316</b>	11,11	7/16	7/16" NF x 5/16" NFF	<b>MCC-314</b>	5/16" NFM	<b>MCC-315</b>	5/16" NFF x 5/16" NFF
15,44 ÷ 17,72	0.609 ÷ 0.737	<b>MAT-309-A</b>	5/8" NF x 1/2" NF	<b>MCC-312</b>	12,70	1/2	1/2" NF x 3/8" NFF	<b>MCC-310</b>	3/8" NFM	<b>MCC-311</b>	3/8" NFF x 3/8" NFF
17,72 ÷ 21,11	0.738 ÷ 0.831	<b>MAT-305-A</b>	5/8" NF x 9/16" NF	<b>MCC-308</b>	14,29	9/16	9/16" NF x 3/8" NFF	<b>MCC-306</b>	3/8" NFM	<b>MCC-307</b>	3/8" NFF x 3/8" NFF
21,11 ÷ 26,80	0.832 ÷ 1.055	<b>MAT-301-A</b>	5/8" NF x 5/8" NF	<b>MCC-304</b>	15,88	5/8	5/8" NF x 3/8" NFF	<b>MCC-302</b>	3/8" NFM	<b>MCC-303</b>	3/8" NFF x 3/8" NFF
26,80 ÷ 39,65	1.056 ÷ 1.561	<b>MAT-317-A</b>	5/8" NF x 3/4" NF	<b>MCC-320</b>	19,05	3/4	3/4" NF x 7/16" NFF	<b>MCC-318</b>	7/16" NFM	<b>MCC-319</b>	7/16" NFF x 7/16" NFF
39,65 ÷ 60,30	1.562 ÷ 2.374	<b>MAT-325-A</b>	5/8" NF x 1" NF	<b>MCC-328</b>	25,40	1	1" NF x 7/16" NFF	<b>MCC-326</b>	7/16" NFM	<b>MCC-327</b>	7/16" NFF x 7/16" NFF

# Cleaning drills and brushes

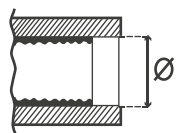

Ø Tool		Size connection		Widia tips						
mm	inches	mm	inches	mm	inches	MAT	MTW	MCB	MCT	MB
9,12 ÷ 9,88	0.359 ÷ 0.389	8,7	0.343	6,35	1/4	MAT 201	MTW 201	MCB 201	MCT 201	MB 201
9,91 ÷ 10,67	0.390 ÷ 0.420	9,5	0.375			MAT 202	MTW 202	MCB 202	MCT 202	MB 202
10,69 ÷ 11,48	0.421 ÷ 0.452	10,3	0.406			MAT 203	MTW 203	MCB 203	MCT 203	MB 203
11,48 ÷ 12,27	0.452 ÷ 0.483	11,1	0.437			MAT 204	MTW 204	MCB 204	MCT 204	MB 204
12,29 ÷ 13,06	0.484 ÷ 0.514	11,9	0.468			MAT 205	MTW 205	MCB 205	MCT 205	MB 205
13,08 ÷ 13,84	0.515 ÷ 0.545	12,7	0.500			MAT 206	MTW 206	MCB 206	MCT 206	MB 206
13,87 ÷ 14,66	0.546 ÷ 0.577	13,5	0.531	7,93	5/16	MAT 207	MTW 207	MCB 207	MCT 207	MB 207
14,68 ÷ 15,44	0.578 ÷ 0.608	14,3	0.562			MAT 208	MTW 208	MCB 208	MCT 208	MB 208
14,68 ÷ 15,44	0.578 ÷ 0.608	14,3	0.562			MAT 108	MTW 108	MCB 108	MCT 108	MB 108
15,47 ÷ 16,23	0.609 ÷ 0.639	15,1	0.593			MAT 209	MTW 209	MCB 209	MCT 209	MB 209
16,26 ÷ 17,15	0.640 ÷ 0.675	15,9	0.625			MAT 210	MTW 210	MCB 210	MCT 210	MB 210
17,17 ÷ 17,93	0.676 ÷ 0.706	16,7	0.656			MAT 211	MTW 211	MCB 211	MCT 211	MB 211
17,96 ÷ 18,72	0.707 ÷ 0.737	17,5	0.687	9,52	3/8	MAT 212	MTW 212	MCB 212	MCT 212	MB 212
18,75 ÷ 19,53	0.738 ÷ 0.769	18,2	0.718			MAT 213	MTW 213	MCB 213	MCT 213	MB 213
19,56 ÷ 20,32	0.770 ÷ 0.800	19,1	0.750			MAT 214	MTW 214	MCB 214	MCT 214	MB 214
20,35 ÷ 21,11	0.801 ÷ 0.831	19,9	0.781			MAT 215	MTW 215	MCB 215	MCT 215	MB 215
21,13 ÷ 21,89	0.832 ÷ 0.862	20,6	0.812			MAT 216	MTW 216	MCB 216	MCT 216	MB 216
21,92 ÷ 22,71	0.863 ÷ 0.894	21,4	0.843			MAT 217	MTW 217	MCB 217	MCT 217	MB 217
22,73 ÷ 23,50	0.895 ÷ 0.925	22,2	0.875			MAT 218	MTW 218	MCB 218	MCT 218	MB 218
23,52 ÷ 24,28	0.926 ÷ 0.956	23,0	0.906			MAT 219	MTW 219	MCB 219	MCT 219	MB 219
24,31 ÷ 25,07	0.957 ÷ 0.987	23,8	0.937			MAT 220	MTW 220	MCB 220	MCT 220	MB 220
25,35 ÷ 26,01	0.998 ÷ 1.024	24,6	0.968			MAT 221	MTW 221	MCB 221	MCT 221	MB 221
26,04 ÷ 26,80	1.025 ÷ 1.055	25,4	1.000			MAT 222	MTW 222	MCB 222	MCT 222	MB 222
26,82 ÷ 27,58	1.056 ÷ 1.086	26,2	1.031			MAT 223	MTW 223	MCB 223	MCT 223	MB 223
27,61 ÷ 28,37	1.087 ÷ 1.117	27,0	1.062	MAT 224	MTW 224	MCB 224	MCT 224	MB 224		
28,40 ÷ 29,18	1.118 ÷ 1.149	27,8	1.093	MAT 225	MTW 225	MCB 225	MCT 225	MB 225		
29,21 ÷ 29,97	1.150 ÷ 1.180	28,6	1.125	MAT 226	MTW 226	MCB 226	MCT 226	MB 226		
30,00 ÷ 30,76	1.181 ÷ 1.211	29,4	1.156	MAT 227	MTW 227	MCB 227	MCT 227	MB 227		
30,78 ÷ 31,55	1.212 ÷ 1.242	30,2	1.187	MAT 228	MTW 228	MCB 228	MCT 228	MB 228		
31,57 ÷ 32,51	1.243 ÷ 1.280	30,9	1.218	11,11	7/16	MAT 229	MTW 229	MCB 229	MCT 229	MB 229
32,54 ÷ 33,30	1.281 ÷ 1.311	31,8	1.250			MAT 230	MTW 230	MCB 230	MCT 230	MB 230
33,32 ÷ 34,09	1.312 ÷ 1.342	32,5	1.281			MAT 231	MTW 231	MCB 231	MCT 231	MB 231
34,11 ÷ 34,90	1.343 ÷ 1.374	33,3	1.312			MAT 232	MTW 232	MCB 232	MCT 232	MB 232
34,93 ÷ 35,69	1.375 ÷ 1.405	34,1	1.343			MAT 233	MTW 233	MCB 233	MCT 233	MB 233
35,71 ÷ 36,47	1.406 ÷ 1.436	34,9	1.375			MAT 234	MTW 234	MCB 234	MCT 234	MB 234

## Drills choice

Completely obstructed tubes

Partially obstructed tubes

Brushing

Friable deposits

Tough deposits

**MAT**

**MCB**

**MTW**

**MCT**

**MB**



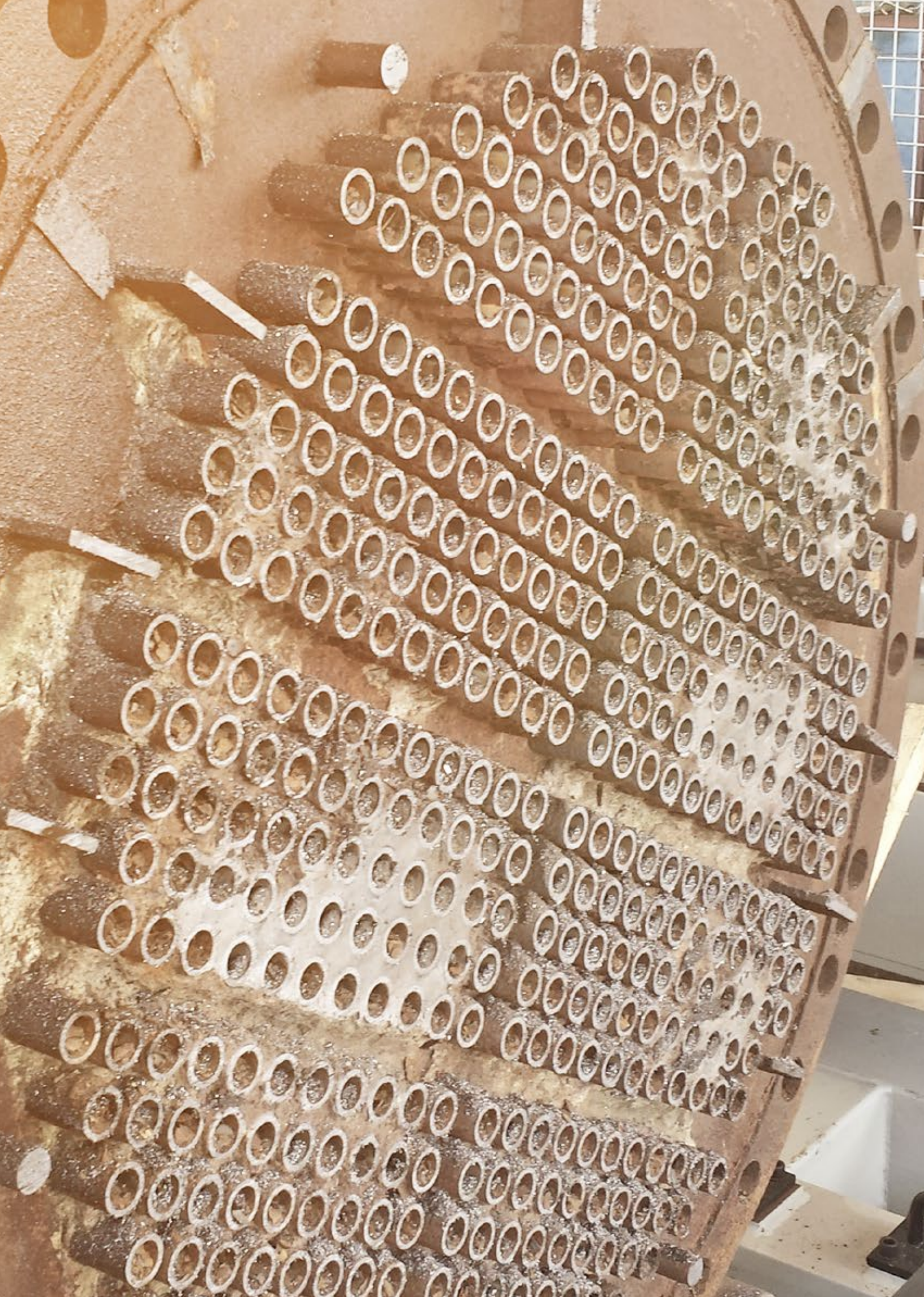



# ***BundleCut Evolution Plus***

*Bandsaw for the dismantling of tube bundle and recovery of heat exchanger tubesheets*

# BundleCut Evolution Plus

**Band saw for the dismantling of tube bundle and recovery of heat exchanger tubesheets**  
*Allows rapid and clean separation of the tubesheet from the rest of the bundle*

For when it becomes impossible to partially retubing the tube bundle from a heat exchanger, Maus Italia proposes the BundleCut Evolution Plus band saws for the rapid, safe and ecological retrieval of the tubesheet.

BundleCut has become "Evolution Plus".

Years of product evolution have allowed a complete review of the design, enabling Maus Italia's band saws to be even safer, better performing, more precise and state-of-the-art.

Thanks to the high level of cleanness in the cut, in combination with the Grippul Series quick-fastening stub extractor and Onlypul and Runpul continuous tube extractors, the BundleCut Evolution Plus facilitates and speeds up the recovery of the tubesheet without damaging its holes.

**Used for over 20 years in workshops all around the world**





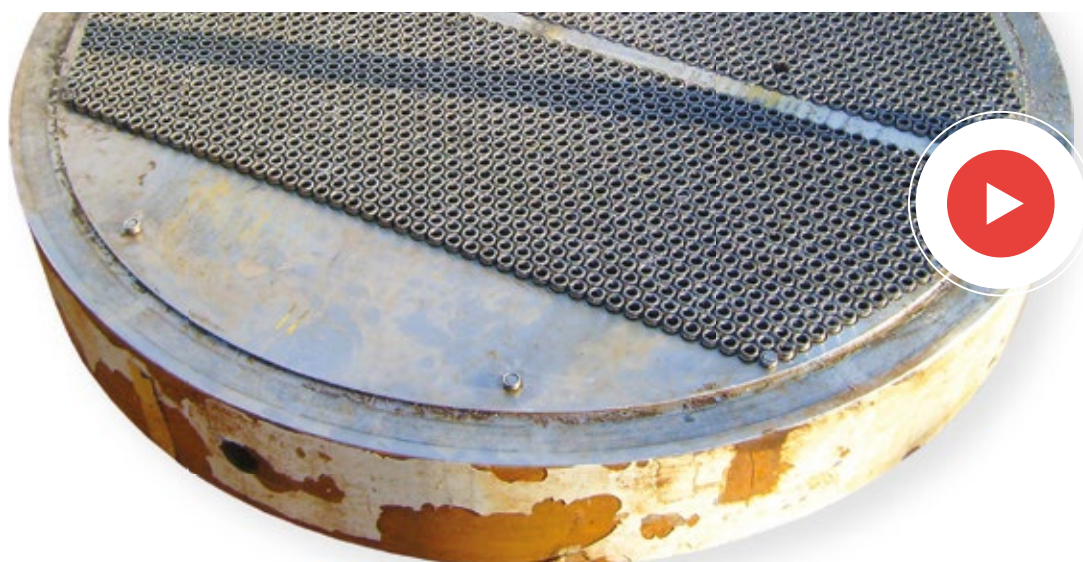

*Watch the video*

## **Exclusive features**



### **Precise and clean cut**

The tube stubs, with no deformities or metallic burrs, are removed easily without damaging the tubesheet holes.



### **Smart cutting**

The ability to continuously control the speed of descent of the cutting arc allows maximum speed without compromising the life of the blade.



### **High safety**

The photo-electric barrier, if crossed, stops the blade automatically to ensure maximum safety in the cutting zone.



### **High productivity**

Thanks to its practicality of use and the speed and precision of the cut, it is indispensable for heat exchanger maintenance workshops.



### **Healthy environment**

The elimination of harmful gases generated by traditional flame cutting and the removal of cutting dust with a grinder make the work environment healthy.



### **High strength**

It can be used for the simultaneous cutting of the shell and the bundle as well as the cutting of solid rounds.



### **Ø max. tubesheet**

**BundleCut Evolution Plus 2000**  
78" (2000 mm)

**BundleCut Evolution Plus 3000**  
118" (3000 mm)



### **Rapid locking (optional)**

The (optional) hydraulic press rapidly locks the tubesheet, safely speeding up the positioning operations.

### Blade rigidity control

The blade guides, operator-adjustable using a hydraulic device, always remain alongside the tube bundle during cutting, ensuring the correct and continuing rigidity of the blade without requiring the machine to be stopped.



### High rigidity in the sliding system

Thanks to pairs of profiled recirculating ball linear guides with high load capacity, the vertical movement of the arc is extremely fluid and rigid. The integrated greasing system extends times between maintenance.



### Compact transmission

The use of transmission chains on the movement of the lifting cylinders reduces the overall dimensions of the BundleCut Evolution Plus and the vertical stroke of the pistons, giving greater stability during a continuous and extremely clean cut.



### Anti collision device



### Chips collector



### Automatic lubricator

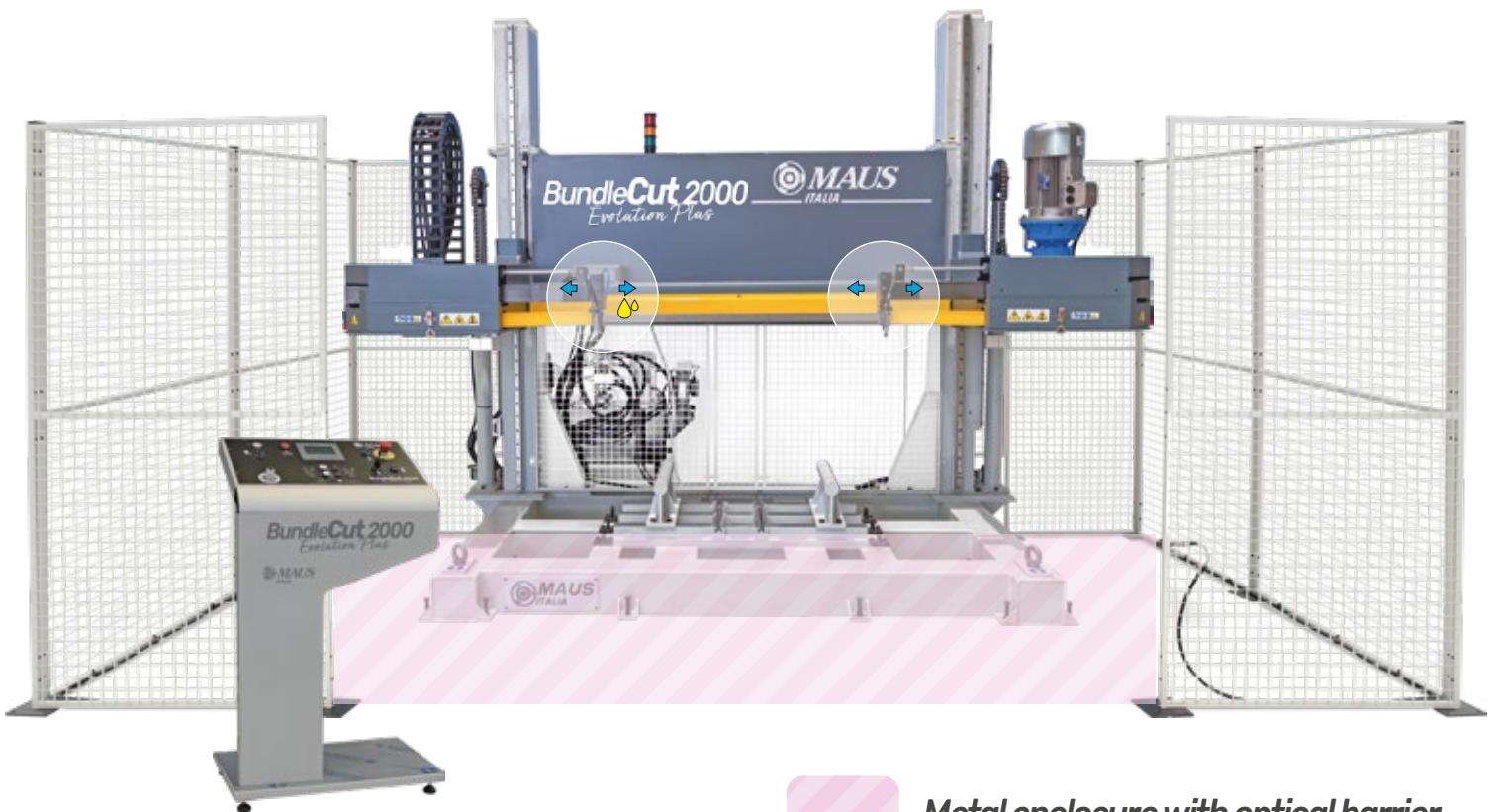

**Metal enclosure with optical barrier**

## User friendly - Control of work parameters

Thanks to the integrated SIEMENS LOGO! TDE panel with NEW touchscreen monitor, the setting and display of parameters is quick and simple.

### Blade

- Blade motor absorption display
- Adjustment of blade rotation speed
- Blade rotation speed display
- Storage of set cutting speed

### Arc

- Display of arc descent speed
- Display of distance travelled by arc
- Display of distance remaining to end of cut

### Plus

- Display of time elapsed since beginning of cutting cycle
- Display of time remaining until end of cutting cycle



## Blade tension control

Automatic control of blade tension and total machine stop in case the blade breaks or falls from the flywheels.



## Smart cutting

The ability to continuously control the speed of descent of the cutting arc allows maximum speed without compromising the life of the blade.



## NEW Control panel

SIEMENS LOGO! TDE panel with NEW touchscreen monitor

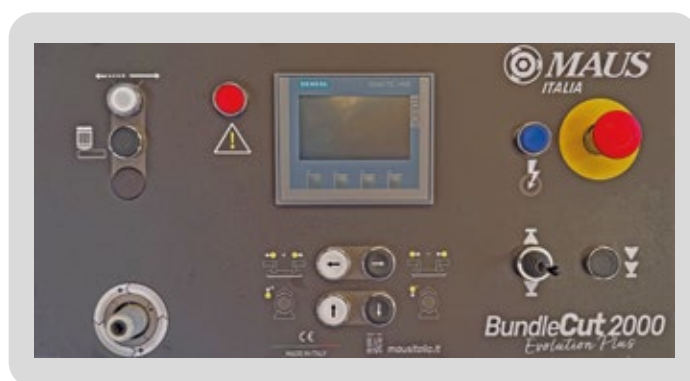









### Precise and clean cut with all materials

To ensure a precise cut without metal burrs, and a long life of the blade, the following can be continuously monitored:

-  Blade tension
-  Automatic opening and closing of the blade guides
-  Lubricant supply
-  Constant air cooling of the blade

By doing so, the tube stubs, non-deformed and without burrs, can be easily removed (with Grippul series tube extractors), without damaging the holes in the tubesheet, thus allowing quick recovery.

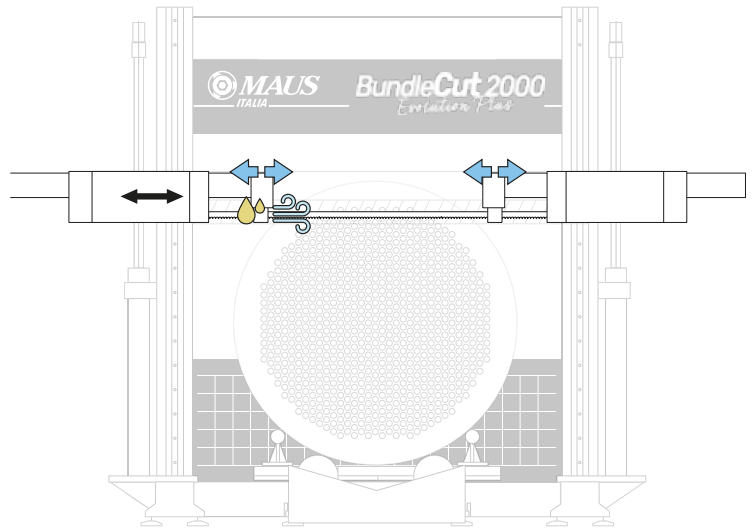

### Removable frame extension

Removable frame extension that allows shipping in 20 fts open top container.



### Machine status reports

Complete range of signals and alarms. These support the operator during the operational phase and job setting.



### Electrical cabinet and maintenance control panel

In addition to the main switch, there are commands to disable the blade motor to unlock or replace the blade.



### Lubrication unit

Pneumatic lubrication system with frequency and deposit capacity regulator for the cutting oil on the blade.



### Hydraulic oil cooling system

Guarantees long periods of use by keeping the hydraulic system oil at the correct temperature.

### Oil tank

The large tank is equipped with an oil temperature control and drainage cap.

### Fixing and levelling feet

18 fixing points for suitable anchor bolts or for fixing on anchor plates. After positioning, these allow the base to be levelled.

### Base and structure in electro-welded steel

Due to its high weight and new technical features, the BundleCut is extremely rigid to guarantee an extremely "clean" cut.



### Blade tight release button

Dedicated button positioned on the machine



## Smart cutting

The exertion of the blade during the cut is directly proportional to the variation in the section of the tube bundle:  
the operator's control of the speed of descent of the cutting arc and the speed of rotation allows maximum speed without compromising the life of the blade.

- ▼ Speed of descent of the cutting arc
- ▶ Speed of blade rotation

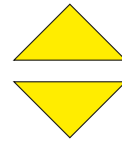
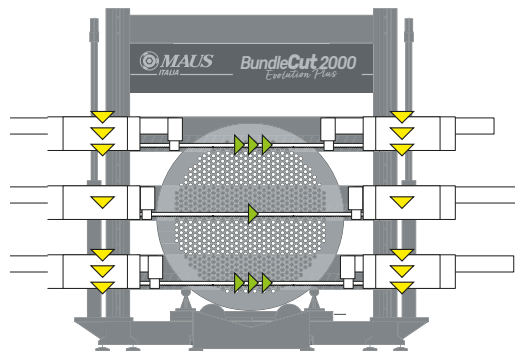

## The ideal combination in tube sheet recovery

The BundleCut Evolution Plus tube bundle band saw is used in combination with the Grippul extractor for the removal of tube stubs, resulting in a tube sheet ready for reuse. To recondition the holes and grooves, we also recommend the use of **FB** brushes and **F26** chasers. For further details on recommended equipment, please refer to the relevant trade brochures.

**FB**  
Steel brushes for reconditioning the holes

**F26**  
Self-centring grooving tool with adjustable depth with interchangeable HSS-Co blades



# Optionals



## Bundle press

In place of anchoring straps with ratcheting tensioner, Maus Italia proposes a device for the rapid locking of the tube plate. It comprises a vertical hydraulic press, controlled from the console, which, mounted on the base, enables the loading of the tube bundle and the unloading of the separated tube sheet to be accelerated.

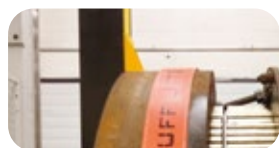
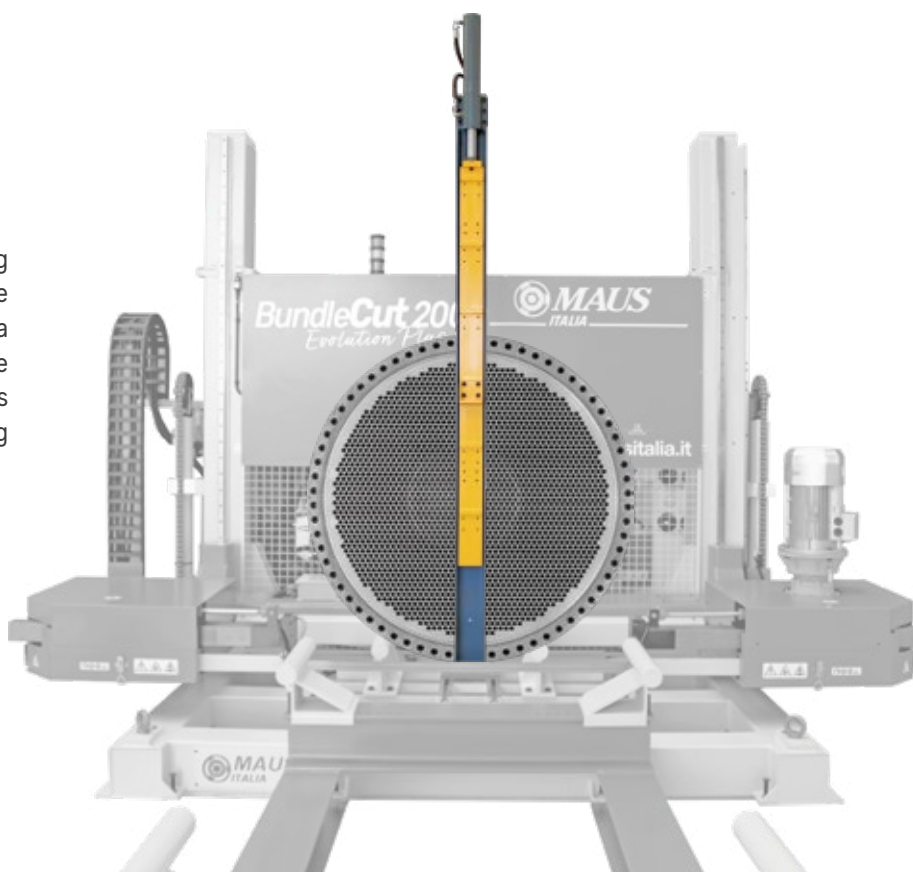

## Bundle support

Modular structure with a standard length of 4000 mm (13 ft) for supporting the tube bundle in front of the BundleCut Evolution Plus with sliding wedges for adaptation to the diameter of the bundle to be cut. Customisable dimensions for shapes and lengths as needed.

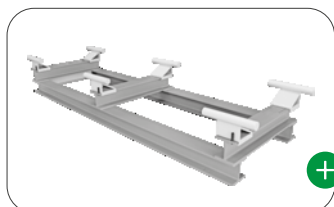

# Cutting procedure

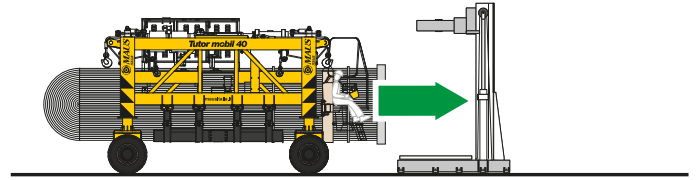

## 1 Positioning

The heat exchanger is positioned in front of the BundleCut Evolution Plus using a bridge crane or BundleTutor Mobil conveyor on to the bundle support and the support brackets are adapted to give the correct support.

## 2 Fixing

The fixing of the tube sheet is ensured by an anchoring strap with a ratchet tensioner or with a BundlePress hydraulic vice (optional) which speeds up the operation.

## 3 Cutting

Operator-controlled cutting with a circular blade allows precision cutting of tube bundle in a short time without polluting the work environment and without damaging the tube stubs being removed.

## 4 Separation

At the final cut, the tube bundle is moved while the tubesheet remains secured to the BundleCut Evolution Plus. The neatly cut tube stubs left in the tube sheet are ready for extraction.

## 5 Stub extraction

Thanks to Grippul series tube extractors, the tube stubs left in the tubesheet are easily removed without damaging the holes.

# Spare parts

## Blades

Maus Italia supplies bimetallic band blades according to the model of selected saw (BundleCut Evolution Plus 2000 or BundleCut Evolution Plus 3000). Selection of the blade is made according to the type of work to be carried out.

The following are factors in the selection:

- the material to be cut
- the thickness of the tubes
- the features of the exchanger shell (if present).

Maus Italia technical staff are available to provide the correct information.



Material to be cut	Z serration	Blade material
Aluminium	4-6	M42
Copper	5-8	M42
Brass	5-8	M42
Carbon steel	6-10	M42
Stainless steel	4-6	M51
Titanium	4-6	M51
Inconel	4-6	M51
Duplex	4-6	M51

# Technical features

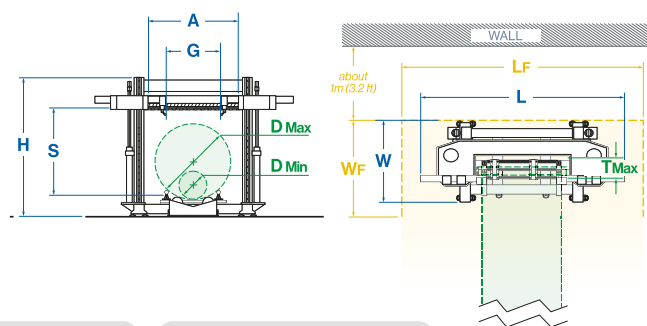

BundleCut Evolution Plus			2000		3000	
∅ tubesheet (max.)	<b>D Max</b>	mm inches	2000	78.7	3000	118.1
* ∅ tubesheet (min.)	<b>D Min</b>	mm inches	200	7.9	350	13.8
Tubesheet thickness (max.)	<b>T Max</b>	mm inches	600	23.6	800	31.5
Cutting speed (min-max.)		m/min ft/min	20-250	65-820	10-140	32-460

BundleCut Evolution Plus			2000		3000	
--------------------------	--	--	------	--	------	--

### Electrical system

* Power supply voltage	V-ph-Hz		400-3-50/60	400-3-50/60
Absorbed power	kW		8,0	16,0
Hydraulic unit power	kW		1,5	4,0
Blade motor power	kW		5,5	11,0

### Hydraulic system

Tank capacity	l	Gal/US	40	10.5	100	26.4
---------------	---	--------	----	------	-----	------

### Pneumatic system

Air supply	bar	PSI	4÷8	58÷116	4÷8	58÷116
------------	-----	-----	-----	--------	-----	--------

### Dimension

Width	<b>L</b>	mm	ft	3730	12.3	5160	17.0
Depth	<b>W</b>	mm	ft	2300	7.6	2300	7.6
Height	<b>H</b>	mm	ft	2950	9.7	3720	12.2
Height without extension		mm	ft	2230	7.3	3000	9.8
Width of required space	<b>LF</b>	mm	ft	4900	16.1	6700	22.0
Depth of required space	<b>WF</b>	mm	ft	2500	7.3	2500	8.2
Blade guide light	<b>G</b>	mm	inches	1900	74.8	2900	114.2
Arc light	<b>A</b>	mm	inches	2200	86.6	3040	119.7
Vertical stroke	<b>S</b>	mm	inches	2000	78.7	3000	118.1
Weight		kg	lb	3700	8160	7700	16980
Degree of protection		IP		54		54	

### Shipment

Width  
Depth  
Height  
Case weight  
Total weight

### BundleCut Evolution Plus 2000



Shipment in 20 fts open top container.

### BundleCut Evolution Plus 3000

cm ft 552 18.1  
cm ft 248 8.1  
cm ft 417 13.7  
kg lb 1575 3470  
kg lb 9275 20450



Shipment in wooden case.

\* Refers to use of provided standard fasteners. Customised fixings on request permit the reduction of the diameter as needed

\* For power supplies other than 400V-3ph, Maus Italia supplies a suitable transformer





# *KattexCut*

*Ensures the rapid recovery of the tubesheet by facilitating tube extraction*





# KattexCut

*Ensures the rapid recovery of the tubesheet by facilitating tube extraction*

Maus Italia has solved the problem of tubesheet safeguarding and recovery during the dismantling of heat exchangers. The KattexCut, a patented Maus Italia product, instantly cuts the tubes from the tube bundle from the inside, without the production of swarf, thus facilitating subsequent operations, such as:

- the extraction of the tube pieces with Grippul series extractors
- the extraction of the tubes with Runpul series continuous extractors

**Instant cuts the tubes from the tube bundle from the inside**

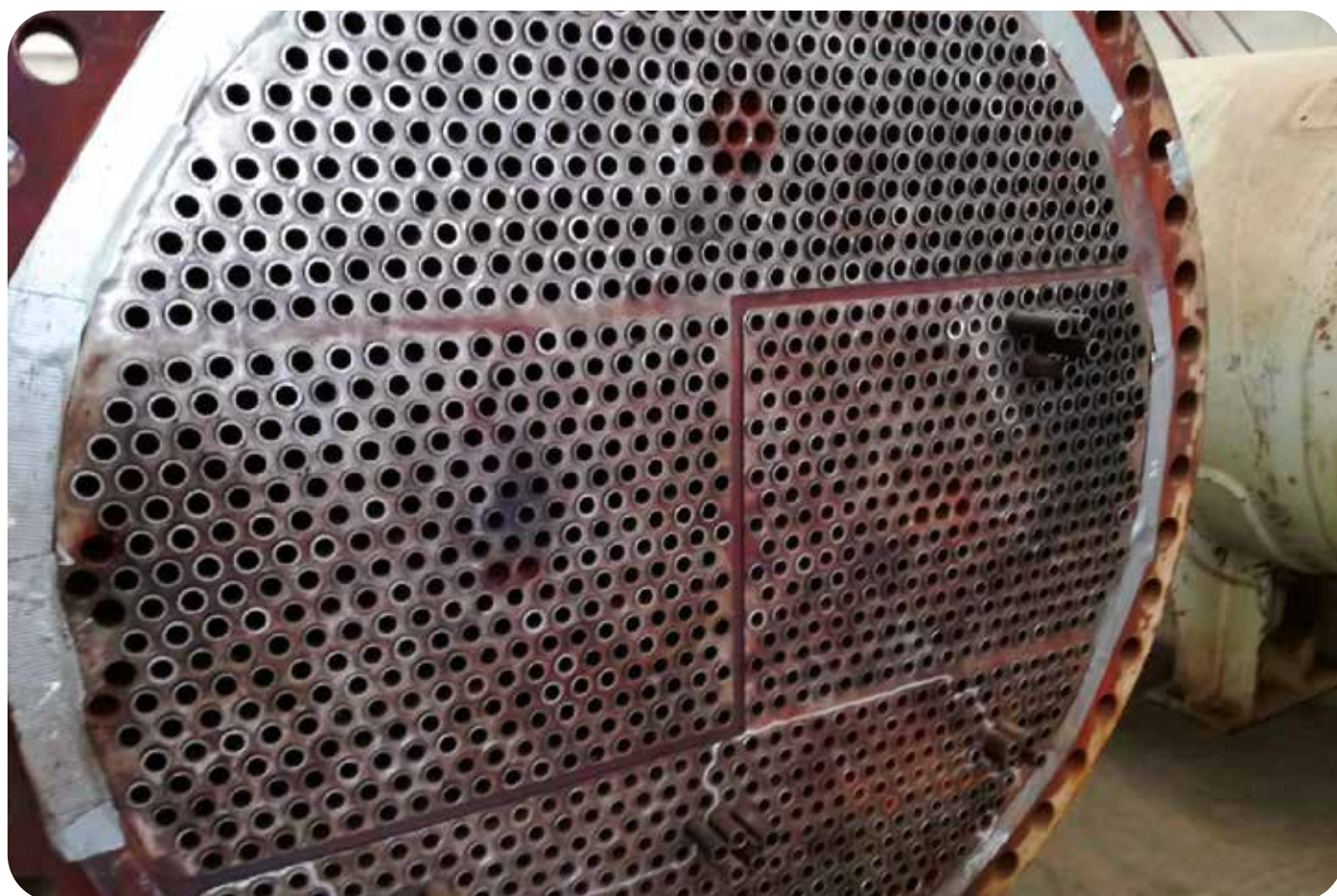

## **| Main features**



### **Instant**

Using hydraulic drive the KattexCut device gives the tools a radial expansion by incising the tube thickness creating the breaking point, ensuring high productivity.



### **Swarf free cutting**

The KattexCut thanks to its patented cutting system, does not leave any metallic residue inside the tube, giving a result which is always "clean".



### **Wide range of application**

Thanks to the two different sizes of Kattex, the KattexCut device allows the intervention on tubes up to 4" (101,60 mm) for the production of industrial boilers.



### **Different power supplies**

The KattexCut's hydraulic drive is given by using the the Maus Italia TP2 series hydraulic power units in either the Electric or Pneumatic versions.

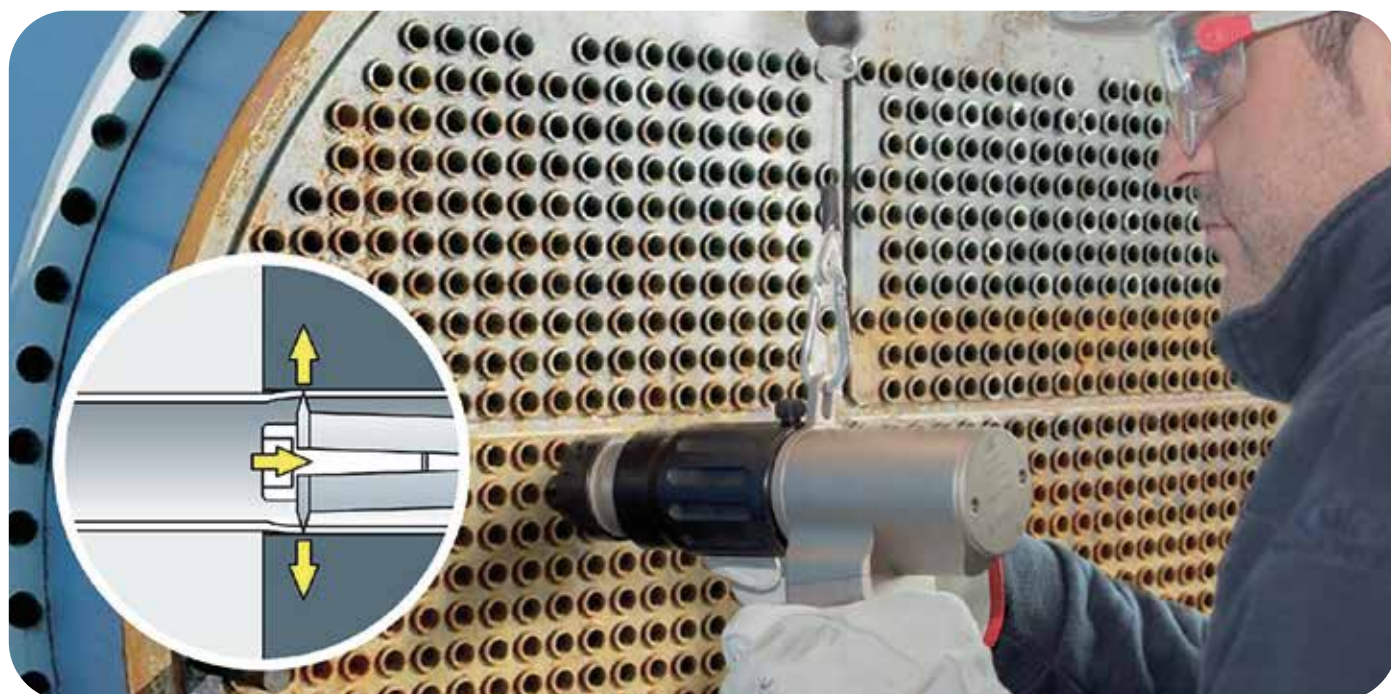

# Work procedure

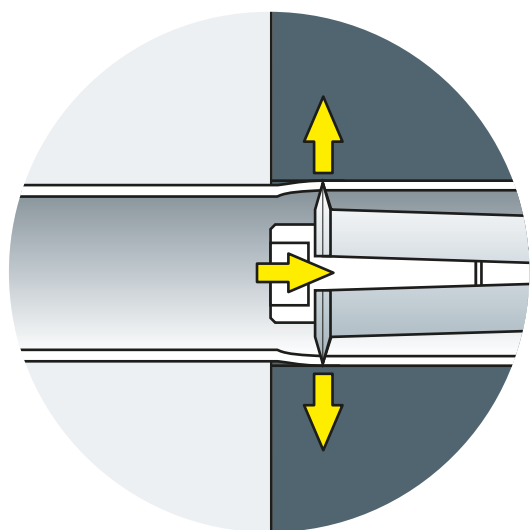

The KattexCut works on the inside of the tube to be cut and, thanks to the hydraulic force from its dedicated power unit, expands the incisor/cutter ( K5K or KI2K ) that penetrates the thickness of the tube. The incising of the tube is sufficient to create a breaking point and facilitate subsequent extraction operations.

If necessary, for a complete cutting of the tube, repeat the operation by rotating the device ( example opposite shows 4 sectors on the side ).

Cut tube sector

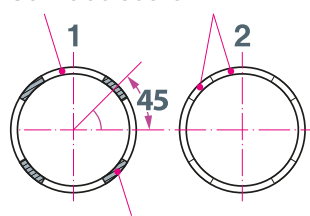

Attached tube sector

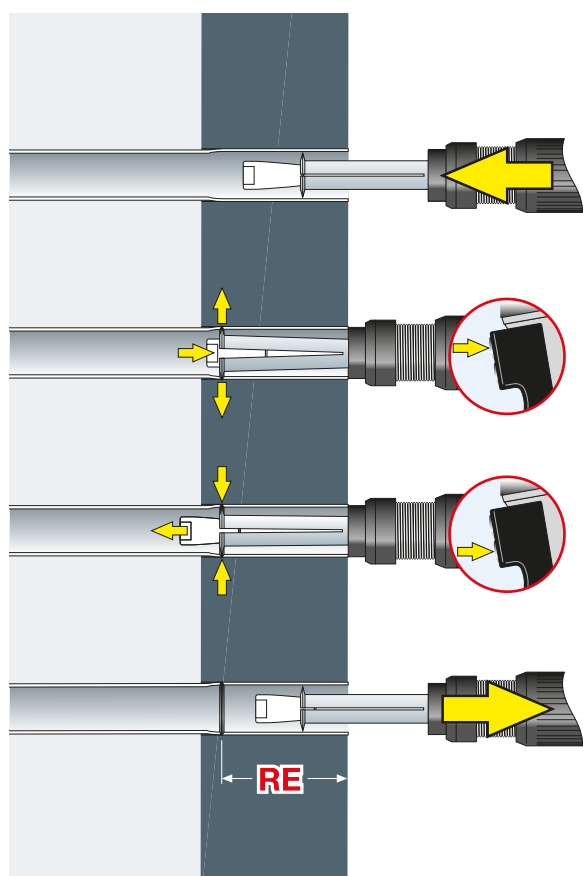

- 1 Insertion**  
Insert the KattexCut into the tube as far as the thrust collar.
- 2 Instant cutting**  
Press the button until the tube is incised.
- 3 Release**  
Press the button until the tool unlocks and the tube is released.
- 4 Removal**  
Extract the KattexCut from the cut tube and proceed with cutting or with the extraction of the tube stub with a Grippul series extractor.



# Kattex6E Kattex12E

Multiuse Electric hydraulic tools

## Electric hydraulic power unit

Maus Italia TP2 series Electric hydraulic power unit recommended for use with Kattex6E and Kattex12E



**TP2E**





## Standard supply

- Hydraulic tool: Kattex 6E or Kattex 12E
- Set of cone reducer couplings
- Set of cutter reducer couplings
- Set of service wrenches
- Thrust collar extension
- Multipole electric cable (with TEAFLEX conduit)- Length 6 m (19.7 ft)
- 2No. R8 - 1/4hydraulic hoses (oil supply and return) - Length 6 m (19.7 ft)
- Instruction manual
- Carrycase

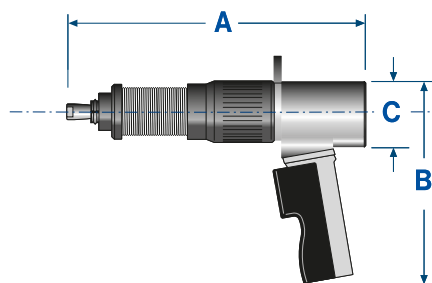

### Technical features

### Kattex 6E

### Kattex 12E

Max work pressure	bar	psi	350	<b>5000</b>	350	<b>5000</b>
Max expansion force	T	lbs	6	<b>13200</b>	12	<b>26400</b>
Cycle time ( expansion + return )	sec	sec	5	<b>5</b>	14	<b>14</b>
Weight	kg	lbs	3,5	<b>7.7</b>	7,0	<b>15.4</b>
Level of protection	IP	IP	55	<b>55</b>	55	<b>55</b>
Controls - Low voltage ( handgrip )	VCA	VCA	24	<b>24</b>	24	<b>24</b>
Ø tubes max	<b>OD</b>	mm	38,10	<b>1.1/2"</b>	107,95	<b>4.1/4"</b>
Lenght	<b>A</b>	mm	290	<b>11.4"</b>	309	<b>12.2"</b>
Widht	<b>B</b>	mm	220	<b>8.6</b>	320	<b>12.6</b>
Height	<b>C</b>	mm	67	<b>2.6</b>	89	<b>3.5</b>
Vibrations	m/s <sup>2</sup>	m/s <sup>2</sup>	0.413	<b>0.413</b>	0.413	<b>0.413</b>
Colours			Al OX - Black		Al OX - Black	
Recommended balancer			TPB-1		TPB-2	

# Kattex6P Kattex12P

Multiuse Pneumatic hydraulic tools

## Pneumatic hydraulic power unit

Maus Italia TP2 series Pneumatic hydraulic power unit recommended for use with Kattex6P and Kattex12P



**TP2P**

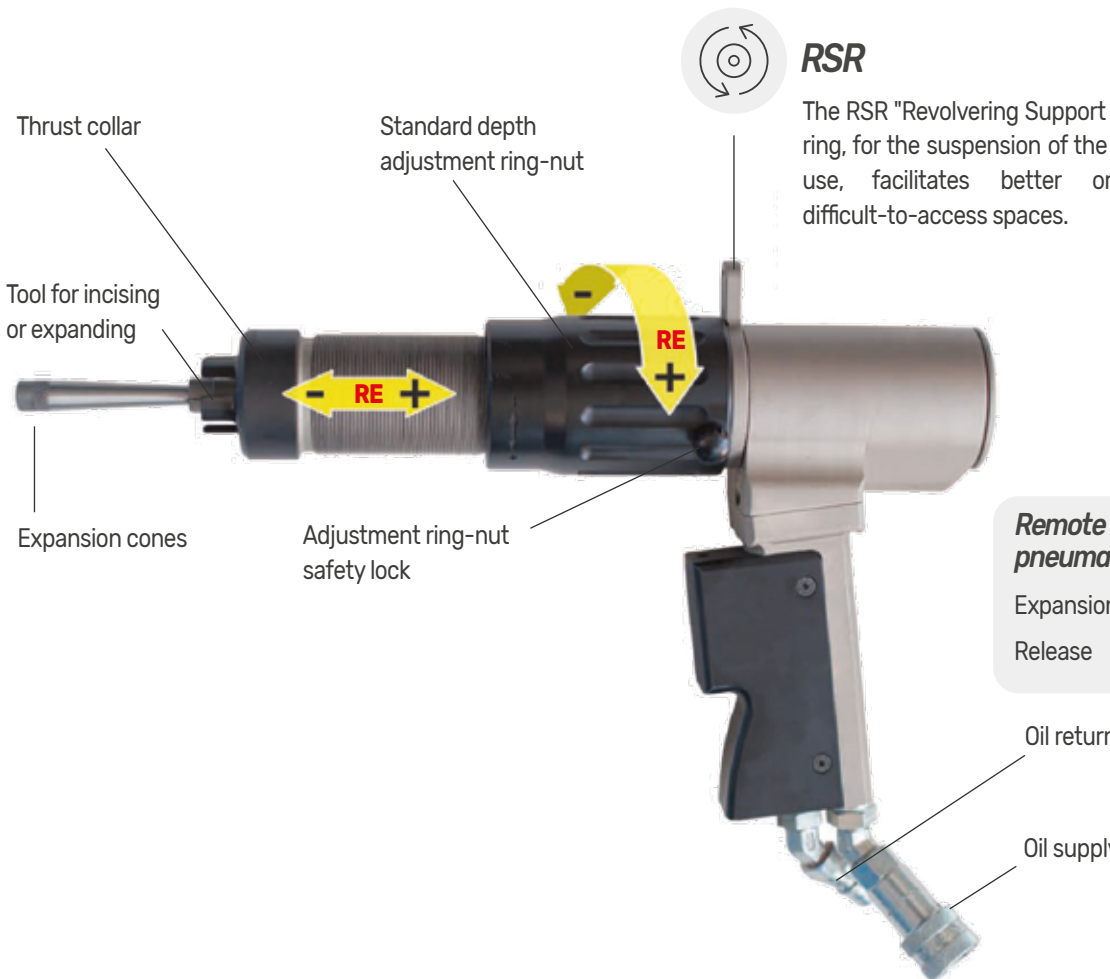

### RSR

The RSR "Revolving Support Ring" rotating ring, for the suspension of the Kattex during use, facilitates better orientation in difficult-to-access spaces.

**Remote foot-operated pneumatic controls**

Expansion

Release



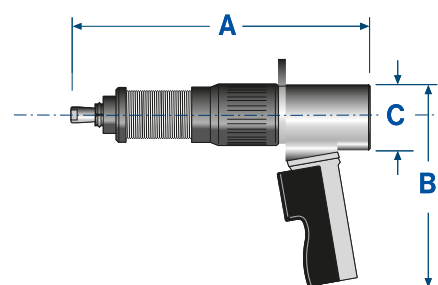

## Standard supply

- Hydraulic tool: Kattex 6P or Kattex 12P
- Set of cone reducer couplings
- Set of cutter reducer couplings
- Set of service wrenches
- Thrust collar extension
- 2No. R8 - 1/4 hydraulic hoses (oil supply and return) - Length 6 m (19.7 ft)
- Instruction manual
- Carrycase

Technical features			Kattex 6P		Kattex 12P	
Max work pressure	bar	psi	350	<b>5000</b>	350	<b>5000</b>
Max expansion force	T	lbs	6	<b>13200</b>	12	<b>26400</b>
Cycle time ( expansion + return )	sec	sec	5	<b>5</b>	14	<b>14</b>
Weight	kg	lbs	3,5	<b>7.7</b>	7,0	<b>15.4</b>
Ø tubes max	<b>OD</b>	mm inches	38,10	<b>1.1/2"</b>	107,95	<b>4.1/4"</b>
Lenght	<b>A</b>	mm inches	290	<b>11.4"</b>	309	<b>12.2"</b>
Widht	<b>B</b>	mm inches	220	<b>8.6</b>	320	<b>12.6</b>
Height	<b>C</b>	mm inches	67	<b>2.6</b>	89	<b>3.5</b>
Vibrations	m/s <sup>2</sup>	m/s <sup>2</sup>	0.413	<b>0.413</b>	0.413	<b>0.413</b>
Colours			Al OX - Black		Al OX - Black	
Recommended balancer			<b>TPB-1</b>		<b>TPB-2</b>	

# Tool assembly diagram for tube incising and cutting

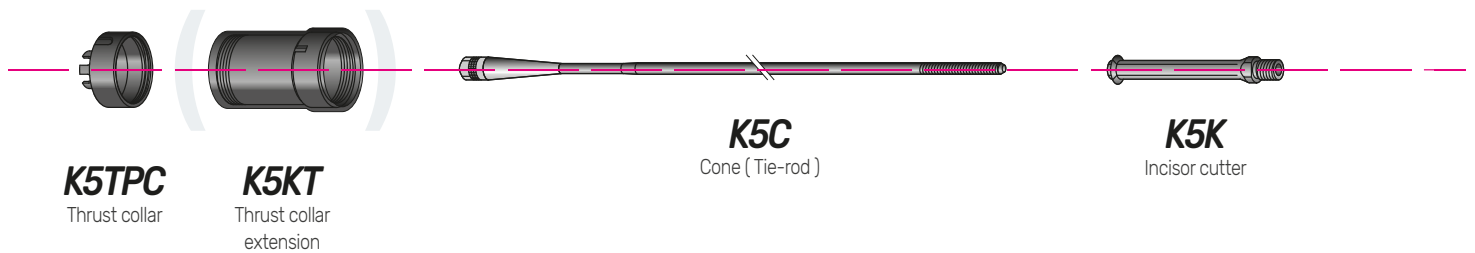

**INCISION ONLY**  
 **COMPLETE CUTTING**

The table is just an introduction to the selection of tools available. For more details, please refer to the documentation supplied with the device

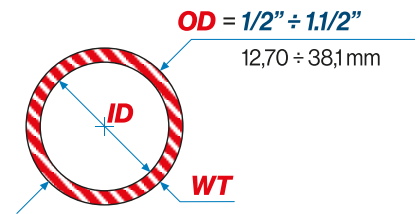

Tube dimensions							Gr	Incisor cutter			Cone reduction coupling
OD			WT		ID		N.	K5K	Expansion		K5RC
inches	mm	B.W.G	mm	inches	mm	inches		Cod.	mm	inches	Cod.
<b>1/2"</b>	12,70	16	1,65	0.065	9,4	0.370	1	<b>K5K-1</b>	9,0÷12,5	0.354÷0.492	<b>K5RC-1-2</b>
		18÷24	1,24÷0,56	0.049÷0.022	10,2÷11,6	0.402÷0.456	2	<b>K5K-2</b>	9,8÷13,3	0.386÷0.524	
<b>5/8"</b>	15,87	14	2,11	0.083	11,7	0.459	3	<b>K5K-3</b>	11,1÷15,3	0.437÷0.602	<b>K5RC-3-4</b>
		16÷24	1,65÷0,56	0.065÷0.022	12,6÷14,8	0.495÷0.583	4	<b>K5K-4</b>	12,1÷16,3	0.476÷0.642	
<b>3/4"</b>	19,05	12	2,77	0.109	13,4	0.532	5	<b>K5K-5</b>	12,8÷18,1	0.504÷0.713	<b>K5RC-5-6</b>
		14÷24	2,11÷0,56	0.083÷0.022	14,8÷17,9	0.584÷0.766	6	<b>K5K-6</b>	14,2÷19,5	0.559÷0.768	
<b>7/8"</b>	22,22	10	3,40	0.134	15,40	0.607	7	<b>K5K-7</b>	14,6÷20,6	0.575÷0.811	<b>K5RC-7-8</b>
		13÷24	2,41÷0,56	0.095÷0.022	17,4÷21,1	0.685÷0.831	8	<b>K5K-8</b>	16,7÷22,7	0.675÷0.894	
<b>1"</b>	25,40	10	3,40	0.134	18,6	0.732	9	<b>K5K-9</b>	17,8÷24,8	0.701÷0.976	<b>K5RC-9-10</b>
		12÷24	2,77÷0,56	0.109÷0.022	19,8÷24,2	0.782÷0.956	10	<b>K5K-10</b>	19,1÷26,1	0.752÷1.027	
<b>1.1/4"</b>	31,75	10	3,40	0.134	25,0	0.982	11	<b>K5K-11</b>	24,0÷31,0	0.945÷1.220	
		12÷24	2,77÷0,56	0.109÷0.022	24,2÷30,7	1.032÷1.206	12	<b>K5K-12</b>	25,3÷32,3	0.996÷1.272	
<b>1.1/2"</b>	38,10	10	3,40	0.134	31,1	1.232	13	<b>K5K-13</b>	30,3÷37,3	1.193÷1.468	
		12÷24	2,77÷0,56	0.109÷0.022	32,5÷37,0	1.282÷1.456	14	<b>K5K-14</b>	31,7÷38,7	1.248÷1.524	

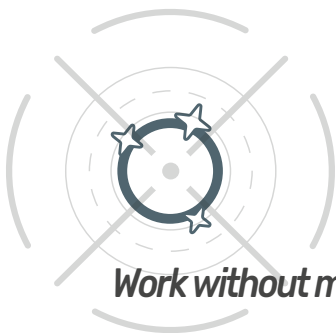

# KattexCut 6

Instant hydraulic internal incisor for tube with **OD** from 1/2" (12,70 mm) up to 1.1/2" (38,10 mm)

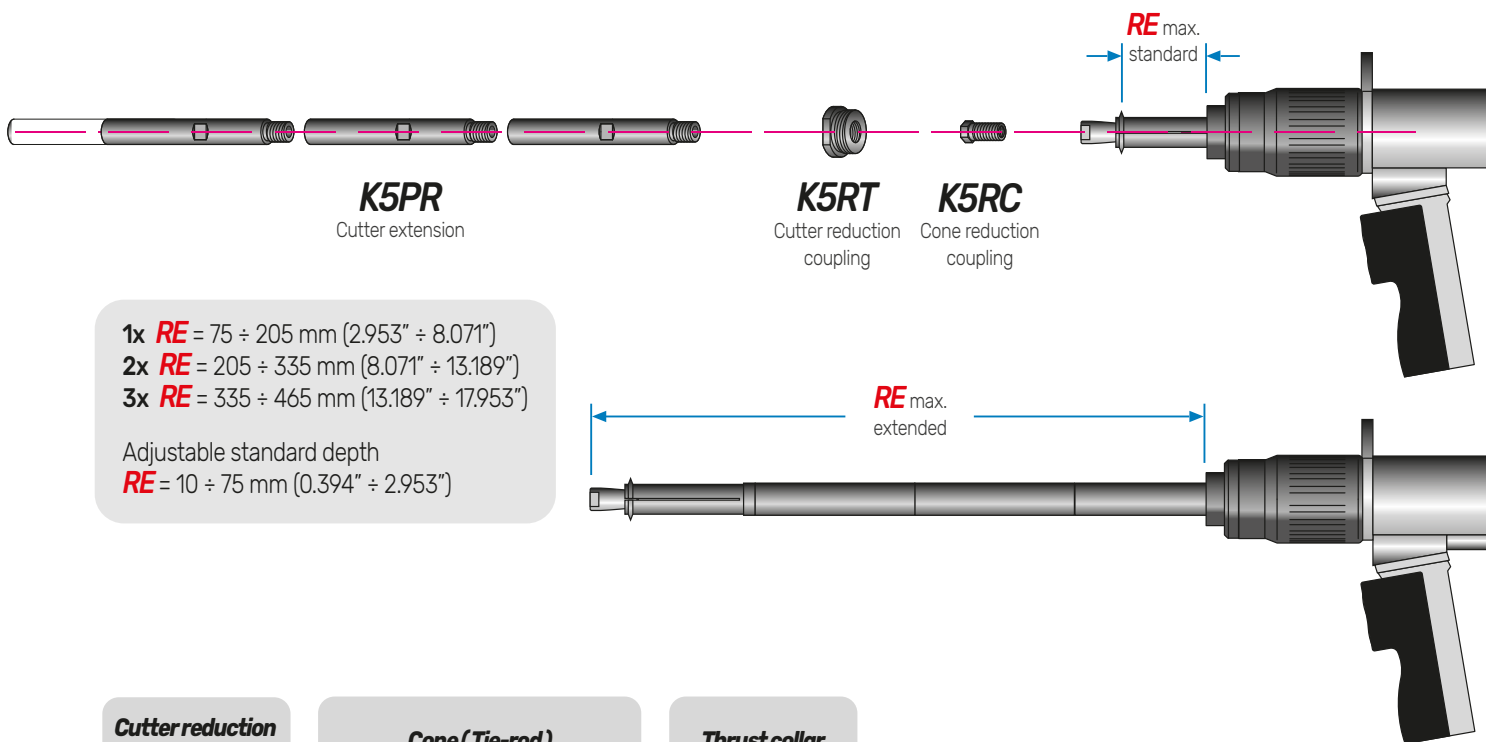

Cutter reduction coupling		Cone (Tie-rod)		Thrust collar
K5RT	K5C	max pressure		K5TPC
Cod.	Cod.	bar	psi	Cod.
K5RT-1-2	K5C-1-2	50	725	K5TPC-14
K5RT-3-4	K5C-3-4	80	1160	K5TPC-18
K5RT-5-6	K5C-5-6	105	1520	K5TPC-21
K5RT-7-8	K5C-7-8	155	2250	K5TPC-25
K5RT-9-10	K5C-9-10	200	2900	K5TPC-28
K5RT-11-12	K5C-11-12	350	5075	K5TPC-34
K5RT-13-14	K5C-13-14	350	5075	K5TPC-41



# Tool assembly diagram for tube incising and cutting

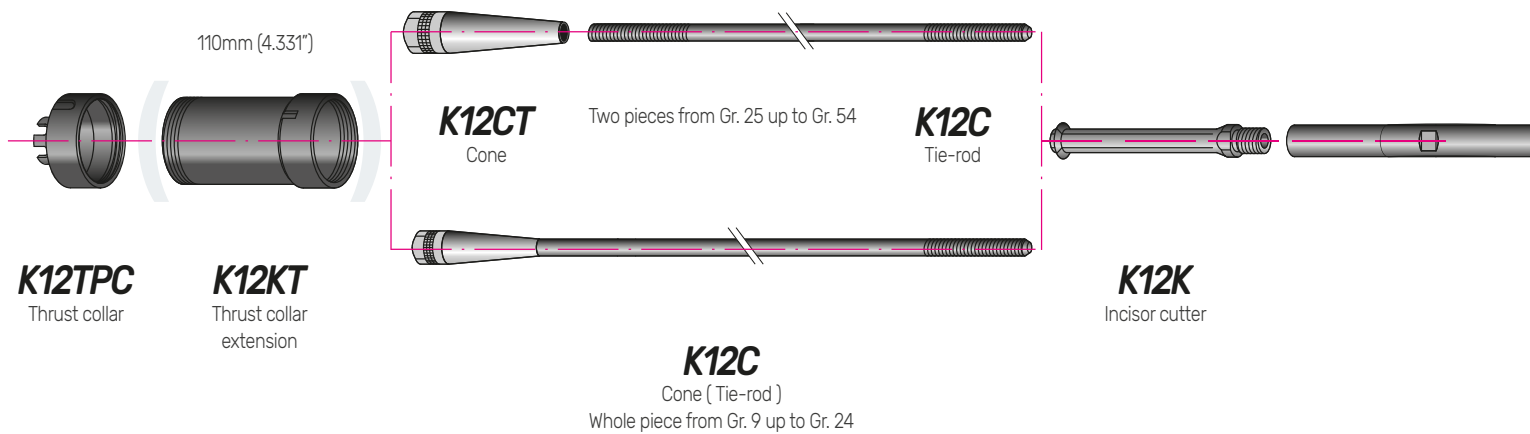

**INCISION ONLY**  
 **COMPLETE CUTTING**

The table is just an introduction to the selection of tools available. For more details, please refer to the documentation supplied with the device

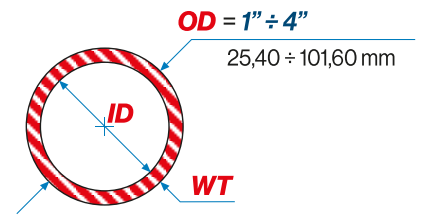

Tube dimensions							Gr	Incisor cutter			Cone reduction coupling
OD			WT		ID		N.	K12K	Expansion		K12RC
inches	mm	B.W.G	mm	inches	mm	inches		Cod.	mm	inches	Cod.
1"	25,4	10	3,40	0.134	18,60	0.732	9	<b>K12K-9#</b>	17,8÷26,2	0.700±1.031	K12RC-9-10
		12	2,77	0.109	19,86	0.782	10	<b>K12K-10</b>	19,2÷27,6	0.756±1.087	
1.1/8"	28,57	10	3,40	0.134	21,77	0.857	10/A	<b>K12K-10/A#</b>	20,9÷29,3	0.823±1.153	K12RC-10/A-10/B
		12	2,77	0.109	23,03	0.907	10/B	<b>K12K-10/B</b>	22,3÷30,7	0.878±1.208	
1.1/4"	31,75	10	3,40	0.134	24,95	0.982	11	<b>K12K-11#</b>	24,0÷32,4	0.945±1.275	K12RC-11-12/B
		12	2,77	0.109	26,21	1.032	12	<b>K12K-12</b>	25,3÷33,7	0.996±1.327	
1.3/8"	34,92	10	3,40	0.134	28,12	1.107	12/A	<b>K12K-12/A</b>	27,2÷35,6	1.071±1.401	K12RC-11-12/B
		12	2,77	0.109	29,38	1.157	12/B	<b>K12K-12/B</b>	28,5÷36,9	1.122±1.453	
1.1/2"	38,10	10	3,40	0.134	31,30	1.232	13	<b>K12K-13</b>	30,3÷38,7	1.193±1.524	K12RC-13-16
		12	2,77	0.109	32,56	1.282	14	<b>K12K-14</b>	31,8÷40,2	1.252±1.583	
1.5/8"	41,27	8	4,19	0.165	32,89	1.295	15	<b>K12K-14</b>	31,8÷40,2	1.252±1.583	K12RC-13-16
		10	3,40	0.134	34,47	1.357	16	<b>K12K-16</b>	33,5÷41,9	1.319±1.649	
1.3/4"	44,45	8	4,19	0.165	36,07	1.420	17	<b>K12K-17</b>	35,0÷43,4	1.378±1.708	-
		10	3,40	0.134	37,65	1.428	18	<b>K12K-18</b>	36,8÷45,2	1.449±1.779	



Work without metallic residues

# KattexCut 12

Instant hydraulic internal incisor for tube with **OD** from 1" (25,40 mm) up to 4" (101,60 mm)

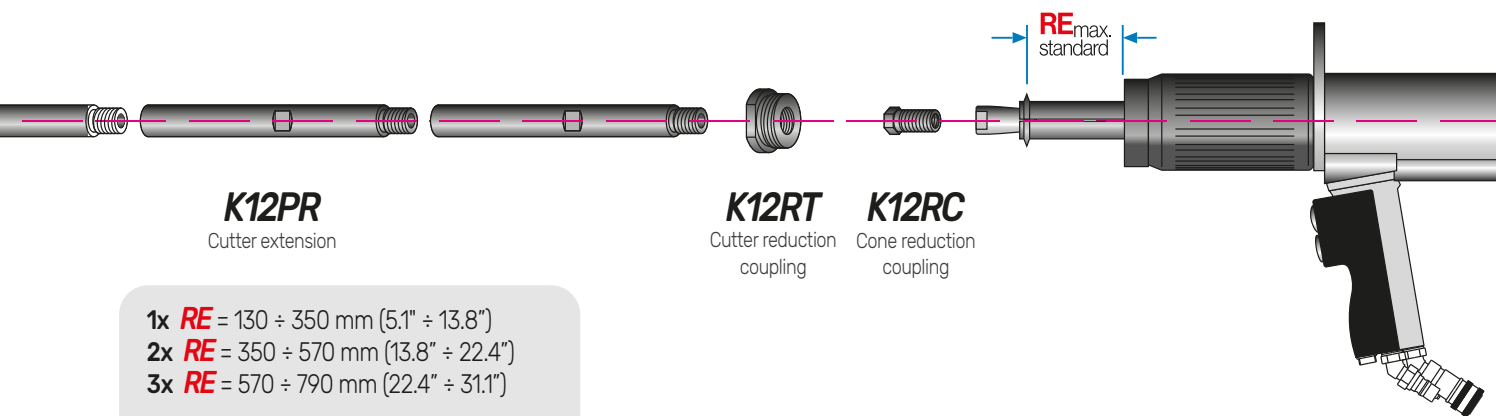

**K12PR**  
Cutter extension

**K12RT**  
Cutter reduction coupling

**K12RC**  
Cone reduction coupling

- 1x **RE** = 130 ÷ 350 mm (5.1" ÷ 13.8")
- 2x **RE** = 350 ÷ 570 mm (13.8" ÷ 22.4")
- 3x **RE** = 570 ÷ 790 mm (22.4" ÷ 31.1")

Adjustable standard depth  
**RE** = -90 ÷ 130 mm (3.543" ÷ 5.118")

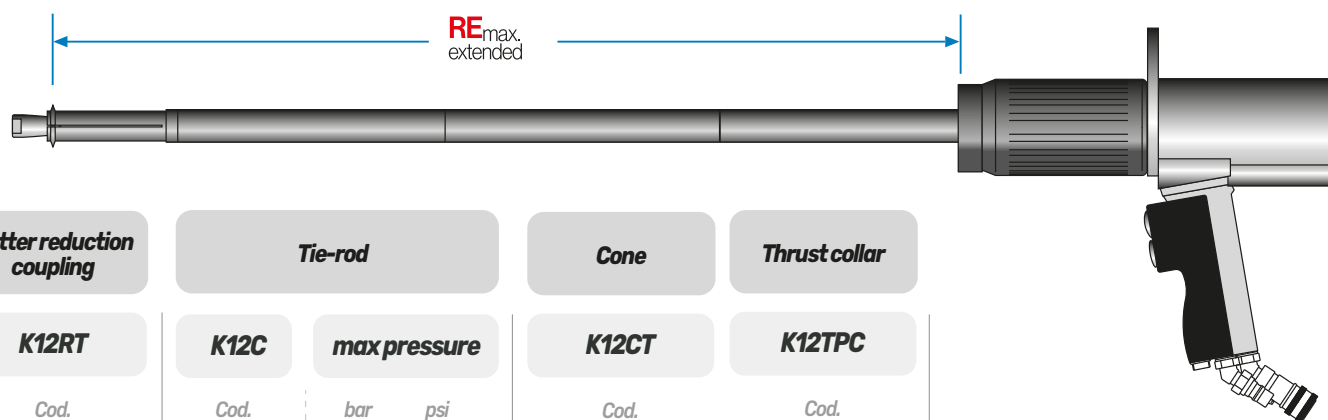

Cutter reduction coupling		Tie-rod		Cone		Thrust collar	
<b>K12RT</b>		<b>K12C</b>		<b>K12CT</b>		<b>K12TPC</b>	
Cod.	Cod.	bar	psi	Cod.	Cod.		
K12RT-9-10	K12C-9-10	90	1300	-	K12TPC-28		
K12RT-10/A-10/B	K12C-10/A-10/B	130	1885	-	K12TPC-31		
K12RT-11-12/B	K12C-11-12/B	230	3335	-	K12TPC-35		
K12RT-11-12/B	K12C-11-12/B	230	3335	-	K12TPC-38		
K12RT-13-16	K12C-13-16	350	5075	-	K12TPC-41		
K12RT-13-16	K12C-13-16	350	5075	-	K12TPC-44		
K12RT-17-20	K12C-17-20	350	5075	-	K12TPC-48		

- INCISION ONLY
- COMPLETE CUTTING

The table is just an introduction to the selection of tools available. For more details, please refer to the documentation supplied with the device

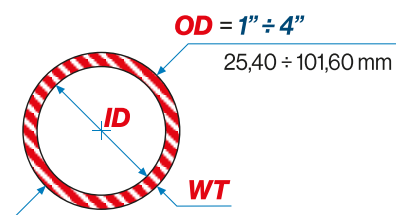

Tube dimensions							Gr	Incisor cutter			Cone reduction coupling
OD			WT		ID			K12K	Expansion		K12RC
inches	mm	B.W.G	mm	inches	mm	inches		N.	Cod.	mm	inches
1.7/8"	47,62	8	4,19	0.165	39,24	1.545	19	K12K-19	38,2÷46,6	1.504÷1.835	-
		10	3,40	0.134	40,82	1.607	20	K12K-20	39,8÷48,2	1.567÷1.897	-
2"	50,80	8	4,19	0.165	42,42	1.670	21	K12K-21	41,4÷49,8	1.630÷1.961	-
		10	3,40	0.134	44,00	1.732	22	K12K-22	43,0÷51,4	1.693÷2.024	-
2.1/8"	53,97	8	4,19	0.165	45,59	1.795	23	K12K-23	44,5÷52,9	1.752÷2.083	-
		10	3,40	0.134	47,17	1.857	24	K12K-24	46,2÷54,6	1.819÷2.149	-
2.1/4"	57,15	8	4,19	0.165	48,77	1.920	25	K12K-25	47,6÷56,0	1.874÷2.205	-
		10	3,40	0.134	50,35	1.982	26	K12K-26	49,5÷57,9	1.949÷2.280	-
2.3/8"	60,32	8	4,19	0.165	51,94	2.045	27	K12K-27	50,8÷59,2	2.000÷2.331	-
		10	3,40	0.134	53,52	2.107	28	K12K-28	52,5÷60,9	2.067÷2.397	-
2.1/2"	63,50	8	4,19	0.165	55,12	2.170	29	K12K-29	54,0÷62,4	2.126÷2.457	-
		10	3,40	0.134	56,70	2.232	30	K12K-30	55,7÷64,1	2.193÷2.524	-
2.5/8"	66,67	8	4,19	0.165	58,29	2.295	31	K12K-31	57,0÷65,4	2.244÷2.575	-
		10	3,40	0.134	59,87	2.357	32	K12K-32	58,5÷66,9	2.303÷2.634	-
2.3/4"	69,85	8	4,19	0.165	61,47	2.420	33	K12K-33	60,0÷68,4	2.362÷2.693	-
		10	3,40	0.134	63,05	2.482	34	K12K-34	62,0÷70,4	2.441÷2.771	-
2.7/8"	73,02	8	4,19	0.165	64,64	2.545	35	K12K-35	63,5÷71,9	2.500÷2.831	-
		10	3,40	0.134	66,22	2.607	36	K12K-36	65,0÷73,4	2.559÷2.890	-
3"	76,20	8	4,19	0.165	67,82	2.670	37	K12K-37	66,5÷74,9	2.618÷2.950	-
		10	3,40	0.134	69,40	2.732	38	K12K-38	68,0÷76,4	2.677÷3.008	-
3.1/8"	79,37	8	4,19	0.165	70,99	2.795	39	K12K-39	69,5÷77,9	2.736÷3.067	-
		10	3,40	0.134	72,57	2.857	40	K12K-40	71,5÷79,9	2.815÷3.145	-
3.1/4"	82,55	8	4,19	0.165	74,17	2.920	41	K12K-41	72,5÷80,9	2.854÷3.185	-
		10	3,40	0.134	75,75	2.982	42	K12K-42	74,5÷82,9	2.933÷3.264	-
3.3/8"	85,72	8	4,19	0.165	77,34	3.045	43	K12K-43	76,0÷84,4	2.992÷3.323	-
		10	3,40	0.134	78,92	3.107	44	K12K-44	77,5÷85,9	3.051÷3.382	-
3.1/2"	88,90	8	4,19	0.165	80,52	3.170	45	K12K-45	79,0÷87,4	3.110÷3.441	-
		10	3,40	0.134	82,10	3.232	46	K12K-46	81,0÷89,4	3.189÷3.520	-
3.5/8"	92,07	8	4,19	0.165	83,69	3.295	47	K12K-47	82,0÷90,4	3.228÷3.559	-
		10	3,40	0.134	85,27	3.357	48	K12K-48	84,0÷92,4	3.307÷3.638	-
3.3/4"	95,25	8	4,19	0.165	86,87	3.420	49	K12K-49	85,5÷93,9	3.366÷3.697	-
		10	3,40	0.134	88,45	3.482	50	K12K-50	87,0÷95,4	3.425÷3.756	-
3.7/8"	98,42	8	4,19	0.165	90,04	3.545	51	K12K-51	88,5÷96,9	3.484÷3.815	-
		10	3,40	0.134	91,62	3.607	52	K12K-52	90,5÷98,9	3.563÷3.894	-
4"	101,60	8	4,19	0.165	93,22	3.670	53	K12K-53	92,0÷100,4	3.622÷3.953	-
		10	3,40	0.134	94,80	3.732	54	K12K-54	93,5÷101,9	3.681÷4.012	-



# KattexCut 12

Instant hydraulic internal incisor  
for tube with **OD** from 1" (25,40 mm)  
up to 4" (101,60 mm)

Cutter reduction coupling		Tie-rod		Cone	Thrust collar
K12RT	K12C	max pressure		K12CT	K12TPC
Cod.	Cod.	bar	psi	Cod.	Cod.
K12RT-17-20	K12C-17-20	350	5075	-	K12TPC-51
K12RT-21-22	K12C-21-22	350	5075	-	K12TPC-54
K12RT-23-26	K12C-23-24	350	5075	-	K12TPC-57
K12RT-23-26	K12C-25-54	350	5075	K12CT-25-26	K12TPC-60
-	K12C-25-54	350	5075	K12CT-27-28	K12TPC-63
-	K12C-25-54	350	5075	K12CT-29-32	K12TPC-66
-	K12C-25-54	350	5075	K12CT-29-32	K12TPC-70
-	K12C-25-54	350	5075	K12CT-33-36	K12TPC-73
-	K12C-25-54	350	5075	K12CT-33-36	K12TPC-76
-	K12C-25-54	350	5075	K12CT-37-54	K12TPC-80
-	K12C-25-54	350	5075	K12CT-37-54	K12TPC-82
-	K12C-25-54	350	5075	K12CT-37-54	K12TPC-85
-	K12C-25-54	350	5075	K12CT-37-54	K12TPC-90
-	K12C-25-54	350	5075	K12CT-37-54	K12TPC-92
-	K12C-25-54	350	5075	K12CT-37-54	K12TPC-96
-	K12C-25-54	350	5075	K12CT-37-54	K12TPC-99
-	K12C-25-54	350	5075	K12CT-37-54	K12TPC-102
-	K12C-25-54	350	5075	K12CT-37-54	K12TPC-105

# TP2E

## Electric hydraulic power unit



The TP2E electric hydraulic power unit is a lightweight and economic piece of equipment designed and manufactured by Maus Italia to power hydraulic Kattex devices.

- > Voltage: V-ph 400-3
- > Frequency: Hz 50/60
- > Installed power: kW 1,1
- > Voltage for commands: V 24

> Dimensions:

Length: 370mm / 14.5 inches  
 Width: 280mm / 11.0 inches  
 Height: 650mm / 25.6 inches  
 Weight ( no-oil ): 33kg / 73 lbs  
 Weight ( full load-oil ): 40kg / 88 lbs

Noise level: <70 (A) dB  
 Level of protection: IP 55  
 Colours: RAL 7035-9005

> Work capacity

Max oil flow rate: 1,8 l/min - 0.47 USgpm  
 Min Pressure: 40bar / 580psi  
 Max pressure: 320bar / 4641psi  
 Tank capacity: 8 l - 2.1 Us Gal  
 Hydraulic oil: ISO H46

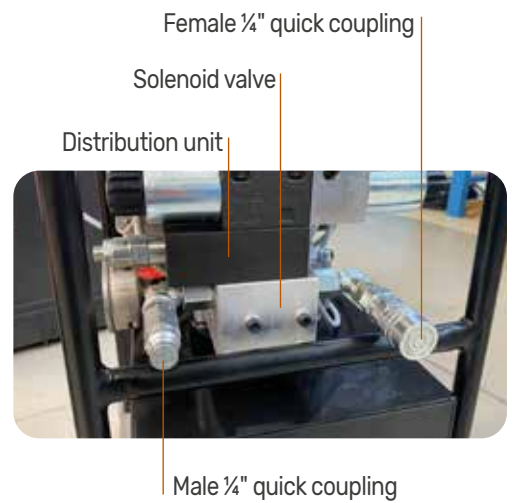

# TP2P

## Pneumatic hydraulic power unit

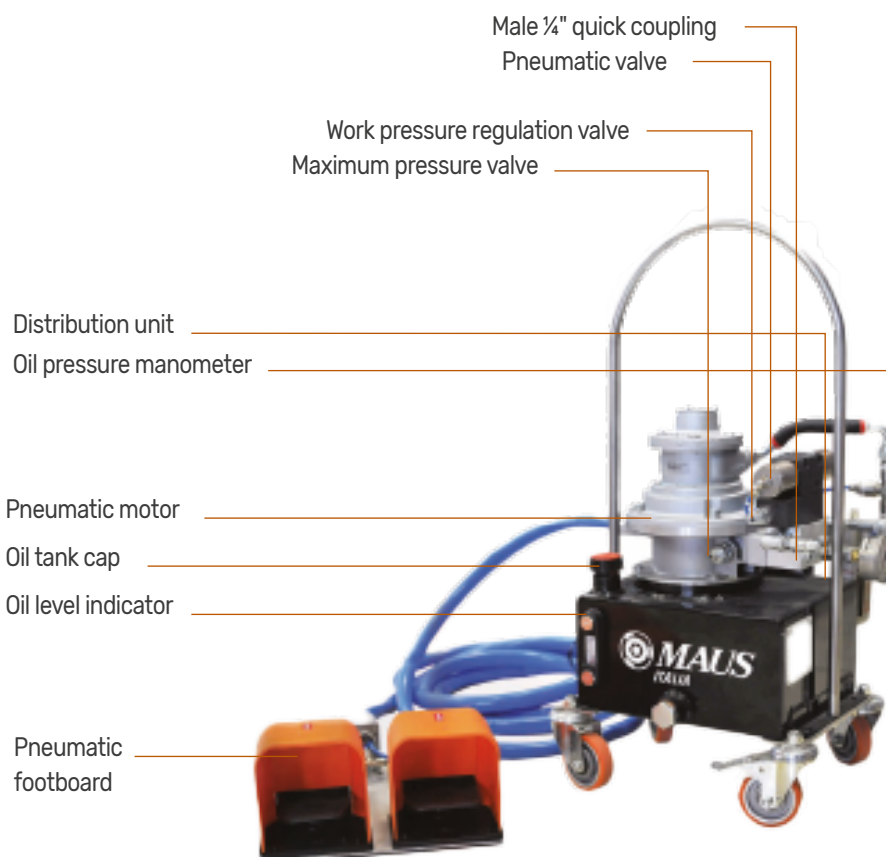

- > Pressure: 5-7bar / 72-101psi
- > Absorbed power: 3 kW
- > Air consumption: 3000 l/min - 792 US gpm

> Dimensions:

Length: 370mm / 14.6 inches  
 Width: 280mm / 11.0 inches  
 Height: 650mm / 25.6 inches  
 Weight ( no-oil ): 36kg / 79.3 lbs  
 Weight ( full load-oil ): 43kg / 94.7 lbs

Noise level: <87 (A) dB  
 Colours: RAL 9005

> Work capacity

Max oil flow rate: 1,8 l/min - 0.47 USgpm  
 Min Pressure: 40bar / 580psi  
 Max pressure: 290bar / 4205psi  
 Tank capacity: 18 l - 2.1 Us Gal  
 Hydraulic oil: ISO H46

The TP2P hydraulic power unit is a lightweight and economic piece of equipment, designed and manufactured by Maus Italia to power hydraulic Kattex devices in the machining for the internal cutting of tubes. Comes supplied with a foot-controlled pneumatic remote control for controlling the loading/return of oil during use.



# F/794

Motor operated tube cutter for medium tube-sheets

This tube cutter is designed for the use in maintenance of heat exchangers and boilers.

**RE<sub>min</sub>** 2" (50,8 mm) ▶ **RE<sub>max</sub>** 6" (152,4 mm)



# F/794/L

Motor operated tube cutter for thick tube-sheets

This tube cutter is designed for the use in aintenance of heat exchangers and boilers. Dedicated to the maintenance of exchangers with very thick tube sheets.

**RE<sub>min</sub>** 4" (101,6 mm) ▶ **RE<sub>max</sub>** 12" (304,8 mm)

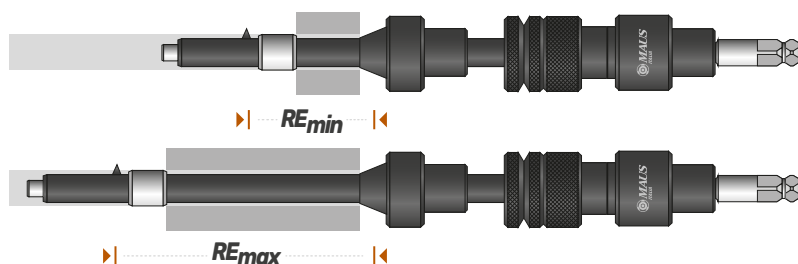

de	Tube cutter	Cutting I.D.		Bit	Tube pilot	∅	Electrical			Pneumatic		
		mm	inches				Cod	(Not included / Order separately indicated for BWG)	mm	inches	Non ferrous tubes	Steel tubes
1/2" (12,7)	<b>F/794-0</b>	8,1 ÷ 15,0	0.32 ÷ 0.59	BIT-F794-0	14 - 16 - 18 - 20 - 22 - 24	3/8" (9,5)	MBOS 16-2		MOF 20 R	MOF 3		
5/8" (15,9)	<b>F/794-1</b>	11,2 ÷ 18,0	0.44 ÷ 0.71	BIT-F794-1	14 - 16 - 18 - 20 - 22 - 24							
3/4" (19,0)	<b>F/794-2</b>	13,5 ÷ 22,0	0.53 ÷ 0.87	BIT-794-2	14 - 16 - 18 - 20 - 22 - 24							
7/8" (22,2)	<b>F/794-3</b>	16,0 ÷ 24,9	0.63 ÷ 0.98	BIT-F794-3-4	14 - 16 - 18 - 20 - 22 - 24							
1" (25,4)	<b>F/794-4</b>	18,0 ÷ 26,9	0.71 ÷ 1.06		14 - 16 - 18 - 20 - 22 - 24	1/2" (12,7)			MOF 3	MOF 3 R		
1.1/4" (31,8)	<b>F/794-5</b>	23,1 ÷ 34,0	0.91 ÷ 1.34	BIT-F794-5-6	12 - 14 - 16 - 18 - 20 - 22							
1.1/2" (38,1)	<b>F/794-6</b>	30,0 ÷ 41,9	1.18 ÷ 1.65		12 - 14 - 16 - 18 - 20 - 22							

\* On request, tube cutter F/794 for bigger diameters are available

# Motorization for F/794

Maus Italia gives indications concernig the pneumatic and elecgric motorizations suitable for the use of the F/794 as well as advise for the selection of the adapter to be used.

## MBOS 16-2

Portable electric drill



- Mechanical 2 speed gear
- Electronic regulator of the rpm for optimal cutting speed
- Optimal control with ergonomic grip and supplementary grip

Electric		MDse 648	
Free voltage	Volt	220V - 50/60 Hz - 1 Ph	
Absorbed power	Watt	740	
Speed No-Load	Lap/min	260-600 / 640-1400	
Speed Full-Load	Lap/min	0-360 / 0-860	
Weight	Kg Lb	3,4	7,5
Dimension	mm "	488 x 82	19.2 x 3.2

**Adapters**

F/311 - 3/8"  
F/312/CIL - 1/2"

## MOF

Portable penumatic drill

- With morse Tape shank
- Two model available: MOF 20R and MOF 3R / Each models are reversible



Pneumatic		MOF 20R		MOF 3		MOF 3R	
Speed	Lap/min	470		170		140	
Power	Watt	745		745		745	
Shank	CM	2		2		2	
Air shank	" gas	3/8" gas		3/8" gas		3/8" gas	
Air consumption	Lt/sec cfm	14	0.49	14	0.49	14	0.49
Weight	Kg Lb	4,5	9.22	4,2	8.82	4,6	10.10
Dimension	Ø x L x h mm	66x236x360		66x272x360		66x241x360	
	Ø x L x h "	2.6 x 8.3 x 14.2		2.6 x 10.7 x 14.2		2.6 x 9.5 x 14.2	

**Adapters**

RCM - 2 - 3/8"  
RCM - 2 - 1/2"

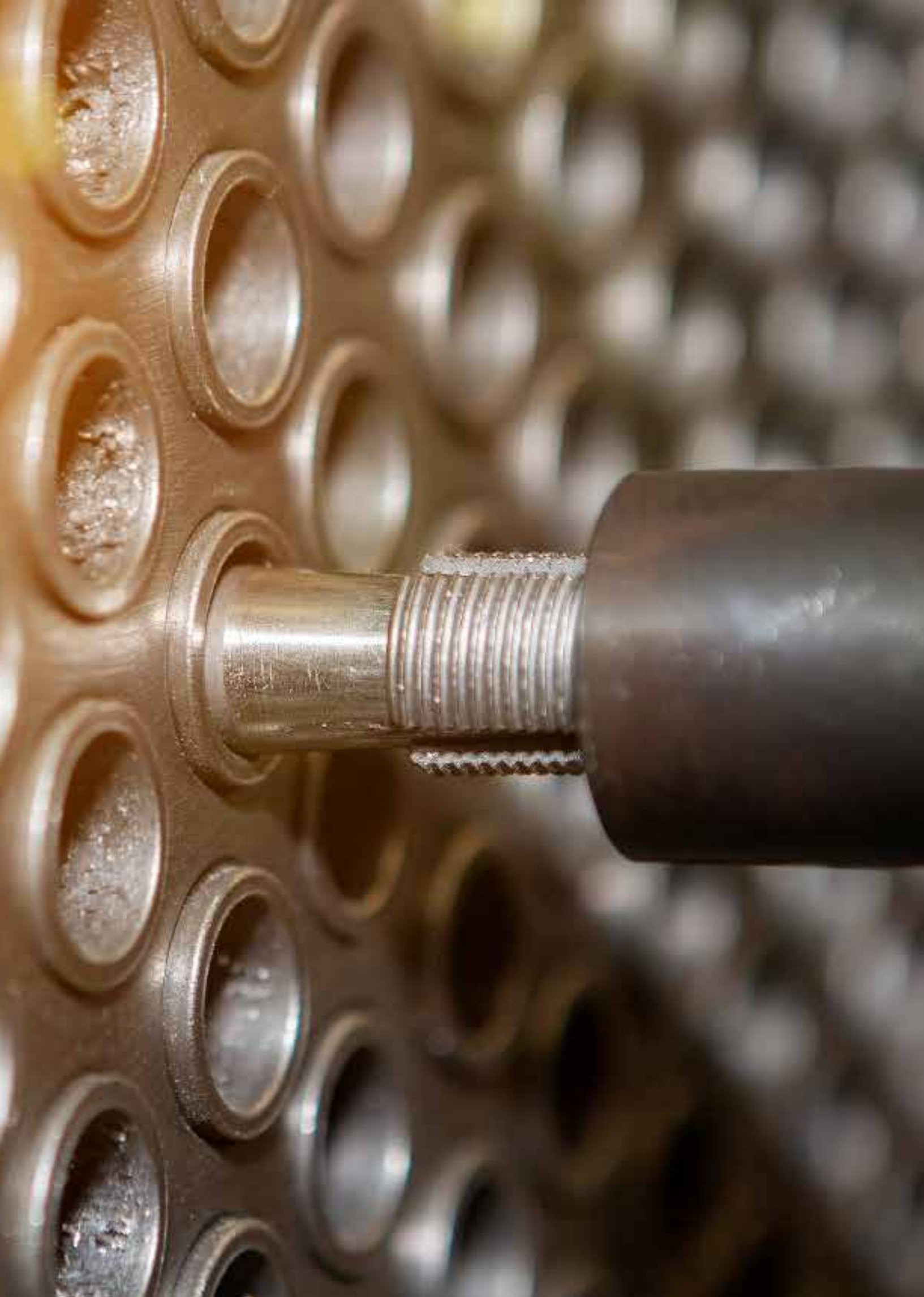



# *Grippul*

*Quick gripping and extracting hydraulic stub puller*

# Grippul

*Quick gripping and extracting hydraulic stub puller*

The quick gripping stub pullers of the Grippul line are the result of more than forty years of experience in tube extraction gathered by Maus Italia. Grippul was designed and manufactured for quick extraction of stubs from tube sheets.

Grippul, electrically or pneumatically operated versions, is equipped with remote control and it is available in two models depending on the extraction force ( Grippul 11 and Grippul 21).

In combination with BundleCut or Kattex, it facilitates and speeds up the recovery of tube sheets.



## **Quick**

From 4 to 6 extractions per minute



## **Flexible**

Tolerance up to 1 mm ( 0.04" ) of tube inner diameter



## **Inexpensive**

Low tool consumption



## **High quality**

Tube sheet hole protection

# The extraction process

Each component was designed according to the most modern and up-to-date technology, especially by analysing the continuous feedbacks we receive from our demanding customers.

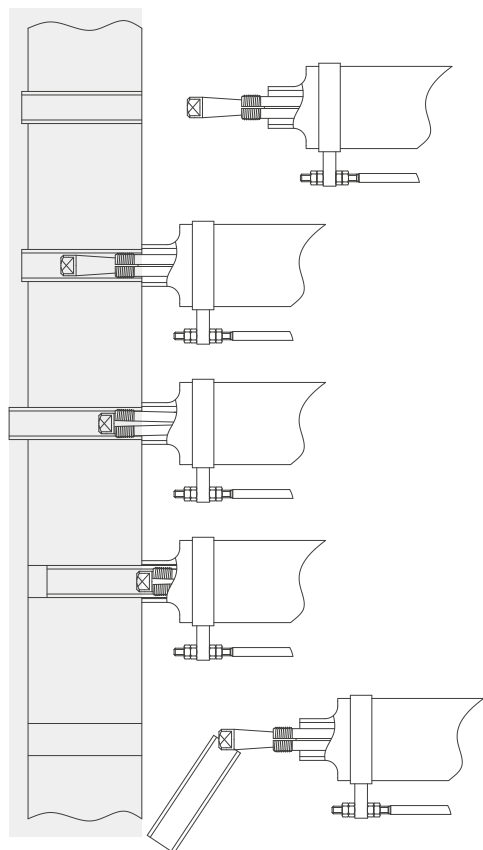

## 1 Positioning

## 2 Insertion

## 3 ABTS - Assisted quick connection (Anti-Breaking Tie-Rod System)

## 4 Extraction (maximum extraction force 10000 Kg / 22000 lb with GRIPPUL 11 and 20000 Kg / 44000 lb with GRIPPUL 21)

## 5 Quick stub release





## Features that make the difference

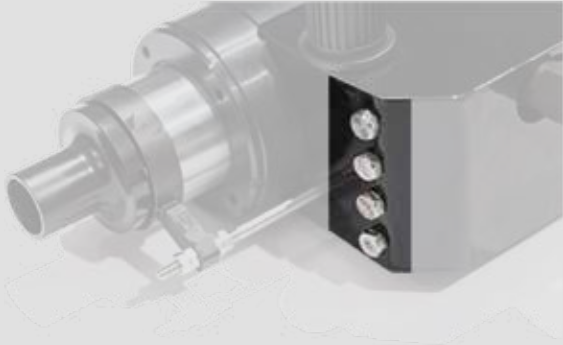

### **ABTS**

The Anti-Breaking Tie-Rod System allows the force with which the jaw penetrates the tube to be regulated to suit the tube's diameter and the material of which it is made. This device means the system is unaffected by the difference in inside diameter of, as much as 1 mm ( 0.04" ), between tubes in the same sheet, preventing tie-rod breakage.



### **OPS**

The electric Over-Pressure Switch cuts off hydraulic fluid delivery when the piston reaches the end of its stroke, preventing unnecessary overpressure in the system.

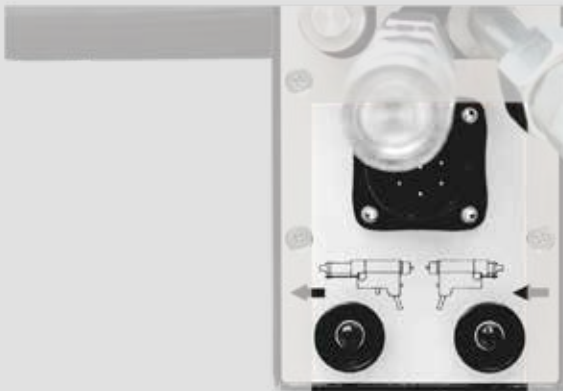

### **RC24**

The RC24 remote control beside the knobs simplifies and speeds up stub extraction. In the electric version it is powered at low voltage 24 Volts.



### **RSR**

The Revolving Support Ring on which the Grippul is suspended during use allows optimal positioning in the tightest spaces.

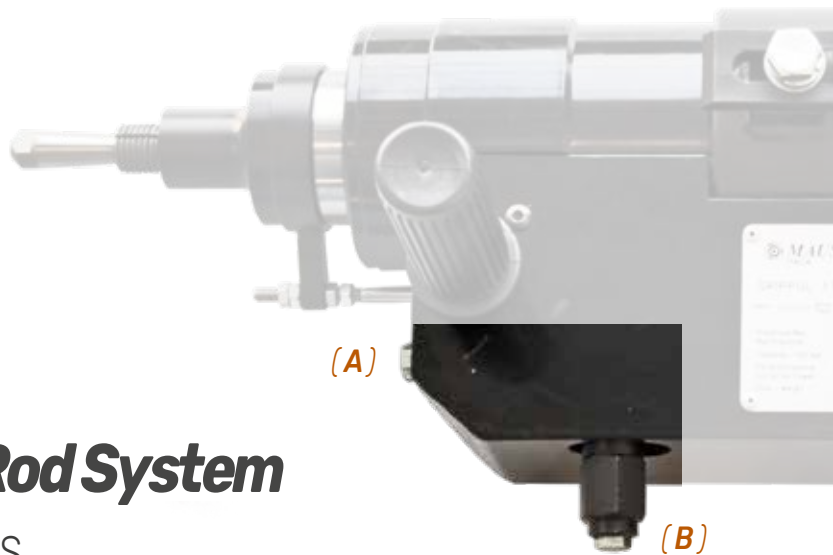

## Anti-Breaking Tie-Rod System

### SAVING AND SAFEGUARDING TOOLS

The Anti-Breaking Tie-Rod System allows the force with which the jaw penetrates the tube to be regulated to suit the tube's diameter and the material of which it is made. This device means the system is unaffected by the difference in inside diameter of, as much as 1 mm (0.04"), between tubes in the same sheet, preventing tie-rod breakage.



GRIPPUL 11 and GRIPPUL 21 are equipped with a set of screws of different lengths stored in the front support **A** to prevent them from being lost.

Depending on which screw is assembled on the hydraulic oil pressure regulating valve **B**, a different gripping force of the jaw is achieved in the stub to be pulled out.

#### Grrippul 11

Forza Power (Kgf)	Pressione Pressure (bar)	L (mm)
1500	75	6,80
2000	100	7,50
3000	150	8,75
4000	200	9,30
5000	250	9,80

#### Grrippul 21

Forza Power (Kgf)	Pressione Pressure (bar)	L (mm)
2000	50	5,50
3000	75	6,80
4000	100	7,50
6000	150	8,75
9000	225	10,40
12000	300	11,90



The hydraulic oil pressure can be monitored by the help of the supplied manometer.

## Over Pressure Switch



The electric Over-Pressure Switch cuts off hydraulic fluid delivery when the piston reaches the end of its stroke, preventing unnecessary overpressure in the system.

A rigid shaft mounted on the inner piston via a ring slides into the microswitch holder controlling the interruption of the hydraulic oil supply.

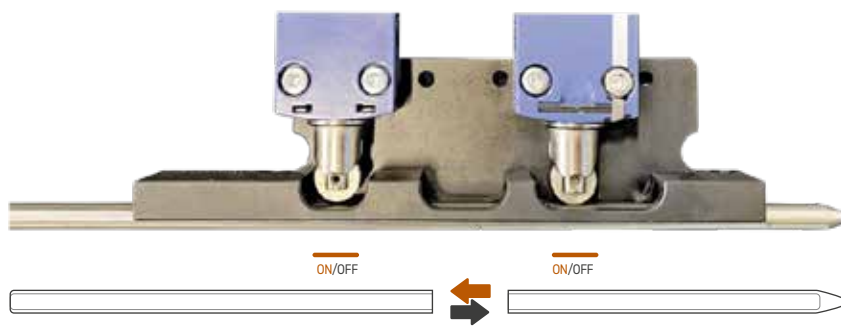

## High Pressure Hydraulic Hoses



High Pressure Hydraulic Hoses, 6 m ( 19.7 ft ) long, are certified for use up to 350 bar ( 5075 psi ). They are equipped with FLAT fittings that reduce dripping during connection and disconnection from GRIPPUL and hydraulic power TP10 unit. They are also equipped with safety systems that prevent a whip effect in the event of a broken hose-fitting connection ( Anti-Whip hoses ).







# Grippul E

## Electric version



## Grippul 11E

- > Tube (*min < de > max*) 12,7 ÷ 38,1 mm / 1/2" ÷ 1.1/2"
- > Maximum extraction force 10000 Kg / 22000 lb
- > Piston stroke 120 mm / 4.72"
- > Max pressure 350 bar / 5075 psi
- > Remote control power supply 24 V

### > Dimensions:

Width:	500 mm / 19.7"
Depth:	113 mm / 4.5"
Height:	270 mm / 10.6"

- > Weight 23 Kg / 51 lb

### > Case

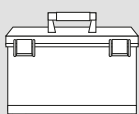

Width:	78 cm / 2.60 ft
Depth:	48 cm / 1.57 ft
Height:	50 cm / 1.64 ft
Gross weight:	48 Kg / 106 lb

## Grippul 21E

- > Tube (*min < de > max*) 25,4 ÷ 63,5 mm / 1" ÷ 2.1/2"
- > Maximum extraction force 20000 Kg / 44000 lb
- > Piston stroke 130 mm / 5.12"
- > Max pressure 350 bar / 5075 psi
- > Remote control power supply 24 V

### > Dimensions:

Width:	600 mm / 23.6"
Depth:	130 mm / 5.1"
Height:	290 mm / 11.4"

- > Weight 35 Kg / 75 lb

### > Case

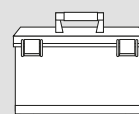

Width:	78 cm / 2.60 ft
Depth:	48 cm / 1.57 ft
Height:	50 cm / 1.64 ft
Gross weight:	60 Kg / 133 lb

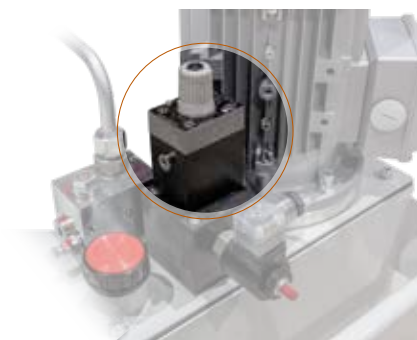

## FRAV

### Flow Rate Adjustment Valve

The Flow Rate Adjustment Valve is required to regulate the flow of hydraulic oil to ensure the best gripping of the jaw in the tube.

## TP10EVV

### Semi-automatic hydraulic power unit

- > Max pressure: 350 bar/5075 psi
- > Oil flow rate:
 

Lt/min ( bar )	US/gpm ( psi )
12 ( 0÷70 )	3.17 ( 0÷1015 psi )
0,9 ( 70÷350 )	0.24 ( 1015÷5075 psi )
- > Hydraulic oil ( not supplied ): 30Lt/8 US Gallon - Viscosità 46
- > Power supply: 1,1 Kw-230/400V-50/60 Hz-3 phase
- > Remote control power supply: 24V
- > IP: 30
- > Dimensions:
 

Width: 680mm / 26.8"
Depth: 500mm / 19.7"
Height: 720mm / 28.3"
- > Weight ( without hydraulic oil ): 86 Kg / 189 lb
- > Box ( power unit + case )



Width:	113 cm / 3.70 ft
Depth:	93 cm / 3.05 ft
Height:	96 cm / 3.15 ft
Gross weight:	211 Kg / 465 lb

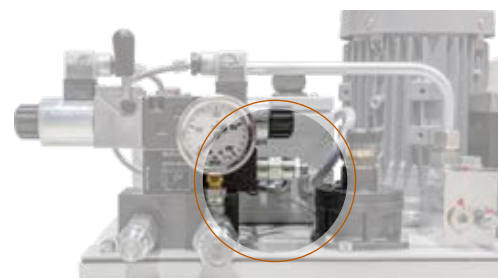

## PAV

### Pressure Adjustment Valve

The Pressure Adjustment Valve is required to adjust the maximum hydraulic oil pressure when using a TP10EVV power unit with KATTEX 6E and KATTEX 12E hydraulic tube cutters



The TP10EVV power unit can also be used in combination with the semi-automatic hydraulic puller ONLYPUL E





# Grippul P

## Pneumatic version



## Grippul 11P

- > Tube ( *min* < *de* > *max* ) 12,7 ÷ 38,1 mm / 1/2" ÷ 1.1/2"
- > Maximum extraction force 10000 Kg / 22000 lb
- > Piston stroke 120 mm / 4.72"
- > Max pressure 350 bar / 5075 psi
- > Remote control power supply 6,3 bar / 91.4 Psi
- > Dimensions:
  - Width: 500 mm / 19.7"
  - Depth: 113 mm / 4.5"
  - Height: 270 mm / 10.6"
- > Weight 23 Kg / 51 lb
- > Case

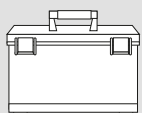

Width: 78 cm / 2.60 ft  
 Depth: 48 cm / 1.57 ft  
 Height: 50 cm / 1.64 ft  
 Gross weight: 48 Kg / 106 lb

## Grippul 21P

- > Tube ( *min* < *de* > *max* ) 25,4 ÷ 63,5 mm / 1" ÷ 2.1/2"
- > Maximum extraction force 20000 Kg / 44000 lb
- > Piston stroke 130 mm / 5.12"
- > Max pressure 350 bar / 5075 psi
- > Remote control power supply 6,3 bar / 91.4 Psi
- > Dimensions:
  - Width: 600 mm / 23.6"
  - Depth: 130 mm / 5.1"
  - Height: 290 mm / 11.4"
- > Weight 35 Kg / 75 lb
- > Case

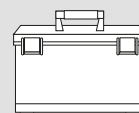

Width: 78 cm / 2.60 ft  
 Depth: 48 cm / 1.57 ft  
 Height: 50 cm / 1.64 ft  
 Gross weight: 60 Kg / 133 lb



## TP10PVV

### Semi-automatic hydraulic power unit

- > Max pressure: 350 bar / 5075 psi
- > Oil flow rate:
 

Lt/min ( bar )	US/gpm ( psi )
12 ( 0÷70 )	3.17 ( 0÷1015 psi )
0,9 ( 70÷350 )	0,24 ( 1015÷5075 psi )
- > Hydraulic oil ( not supplied ): 30Lt/8 US Gallon - Viscosità 46
- > Power supply: 1,7 Kw - 7 bar ( 100 psi )
- > Air consumption: 1900 Lt/min ( 67 Cfm ) - 7 bar / 100 psi
- > Dimensions:
 

Width: 680 mm / 26.8"
Depth: 500 mm / 19.7"
Height: 600 mm / 23.6"
- > Weight ( without hydraulic oil ): 67,5 Kg / 149 lb
- > Box ( power unit + case )



Width:	113 cm / 3.70 ft
Depth:	93 cm / 3.05 ft
Height:	96 cm / 3.15 ft
Gross weight:	192 Kg / 423 lb



## FRAV

### Flow Rate Adjustment Valve

The Flow Rate Adjustment Valve is required to regulate the flow of hydraulic oil to ensure the best gripping of the jaw in the tube.

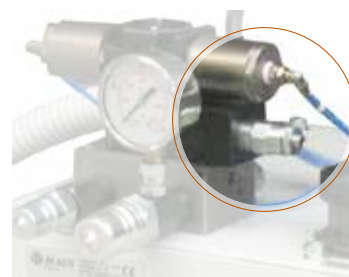

## PAV

### Pressure Adjustment Valve

The Pressure Adjustment Valve is required to adjust the maximum hydraulic oil pressure when using a **TP10EVV** power unit with **KATTEX 6P** and **KATTEX 12P** hydraulic tube cutters



The **TP10PVV** power unit can also be used in combination with the semi-automatic hydraulic puller **ONLYPUL P**



## Equipment

- > Transport case
- > Grippul hydraulic puller
- > N°2 hydraulic hoses (length: 6 m)
- > Manometer
- > Set of spare gaskets
- > Set of service keys
- > Instruction manual



Transport case



Grippul hydraulic puller



No. 2 hydraulic hoses



Manometer



Set of spare gaskets



Set of service keys



Instruction manual



## Optionals



## YRS Set of spare parts

**Model**      *Set of spare parts for 2 years of working*      *Weight*

Grippul 11/E	G11E-YRS-2	2,5 kg / 5.5 lb
Grippul 11/P	G11P-YRS-2	2,5 kg / 5.5 lb
Grippul 21/E	G21E-YRS-2	2,7 kg / 6.0 lb
Grippul 21/P	G21P-YRS-2	2,7 kg / 6.0 lb

## TPB Balancers

**Model**      *Balancers*      *Range*      *Weight*

Grippul 11/E	TPB10	22-25 Kg / 48-55 lb	7,5 Kg / 16.1 lb
Grippul 11/P	TPB10	22-25 Kg / 48-55 lb	7,5 Kg / 16.1 lb
Grippul 21/E	TPB20	30-35 Kg / 66-77 lb	13,1 Kg / 28.9 lb
Grippul 21/P	TPB20	30-35 Kg / 66-77 lb	13,1 Kg / 28.9 lb



## PE Extraction extension

**Tube**      *Extraction extension 120 mm*      *Extraction extension 240 mm*

5/8"	PE120-5/8"	PE240-5/8"
3/4"	PE120-3/4"	PE240-3/4"
7/8"	PE120-7/8"	PE240-7/8"
1.1/4"	PE120-1.1/4"	PE240-1.1/4"
1.1/2"	PE120-1.1/2"	PE240-1.1/2"

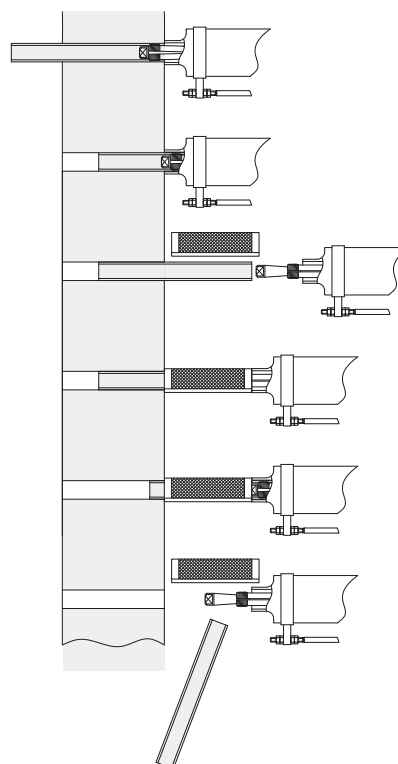

# Grippul 11

## Tool table

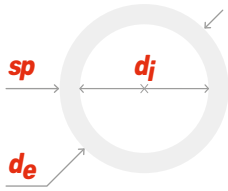

COLLAR TIE-ROD JAW CONE

Tube			Expansion		Jaw	Cone	Tie-rod	Collar			
$d_e$		$sp$	$d_j$								
inches	mm	B.W.G	inches	mm	inches	mm	Cod.	Cod.	Cod.		
1/2" (12,7)	14	0,083	2,11	0,334	8,5	0,335 ÷ 0,393	8,5 ÷ 10,0	<b>G11J-02</b>	<b>G11C 02÷03</b>	<b>G11T 02÷03</b>	<b>TPC-14</b>
	16	0,065	1,65	0,370	9,4	0,347 ÷ 0,433	9,5 ÷ 11,0	<b>G11J-02/A</b>			
	17	0,058	1,47	0,384	9,7						
	18	0,049	1,24	0,402	10,2						
	19	0,042	1,07	0,416	10,5	0,393 ÷ 0,472	10,5 ÷ 12,0	<b>G11J-03</b>			
20	0,035	0,89	0,430	10,9							
5/8" (15,9)	14	0,083	2,11	0,459	11,7	0,452 ÷ 0,512	11,5 ÷ 13,0	<b>G11J-04</b>	<b>G11C 04÷2</b>	<b>G11T 04÷2</b>	<b>TPC-18</b>
	15	0,072	1,83	0,481	12,2	0,492 ÷ 0,551	12,5 ÷ 14,0	<b>G11J-1</b>			
	16	0,065	1,65	0,495	12,6						
	18	0,049	1,24	0,527	13,4						
	19	0,042	1,07	0,541	13,7	0,551 ÷ 0,610	14,0 ÷ 15,5	<b>G11J-2</b>			
	20	0,035	0,89	0,555	14,1						
22	0,028	0,71	0,569	14,5							
3/4" (19,0)	12	0,109	2,77	0,532	13,4	0,531 ÷ 0,610	13,5 ÷ 15,5	<b>G11J-2/A</b>	<b>G11C 2/A÷8</b>	<b>G11T 2/A÷8</b>	<b>TPC-21</b>
	13	0,095	2,41	0,560	14,2	0,571 ÷ 0,650	14,5 ÷ 16,5	<b>G11J-3</b>			
	14	0,083	2,11	0,584	14,8						
	15	0,072	1,83	0,606	15,3						
	16	0,065	1,65	0,620	15,7	0,610 ÷ 0,689	15,5 ÷ 17,5	<b>G11J-4</b>			
	18	0,049	1,24	0,652	16,5						
	19	0,042	1,07	0,666	16,8	0,669 ÷ 0,748	17,0 ÷ 19,0	<b>G11J-5</b>			
	20	0,035	0,89	0,680	17,2						
22	0,028	0,71	0,694	17,6							
7/8" (22,2)	12	0,109	2,77	0,657	16,6	0,650 ÷ 0,728	16,5 ÷ 18,5	<b>G11J-6</b>	<b>G11C 2/A÷8</b>	<b>G11T 2/A÷8</b>	<b>TPC-25</b>
	14	0,083	2,11	0,709	18,0	0,728 ÷ 0,807	18,5 ÷ 20,5	<b>G11J-7</b>			
	16	0,065	1,65	0,745	18,9						
	18	0,049	1,24	0,777	19,7						
	19	0,042	1,07	0,791	20,0	0,787 ÷ 0,866	20,0 ÷ 22,0	<b>G11J-8</b>			
	20	0,035	0,89	0,805	20,4						
22	0,028	0,71	0,819	20,8							

Critical tube dimensions at the limit of extraction capacity for Grippul 11 (10,000 kg / 22,000 lb)  
It depends on the tube material and on the expansion (tube sheet with or without grooves, length of expansion and expansion level)

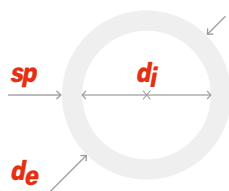

Tube			Expansion		Jaw	Cone	Tie-rod	Collar				
<b>de</b>		<b>sp</b>	<b>dj</b>		inches	mm	Cod.	Cod.	Cod.			
inches	mm	B.W.G	inches	mm	inches	mm	Cod.	Cod.	Cod.			
1"	(25,4)	10	0.134	3,40	0.732	18,6	0.728 ÷ 0.807	18,5 ÷ 20,5	<b>G11J-8/A</b>	G11C 8/A÷11	G11T 8/A÷20	TPC-28
		12	0.109	2,77	0.782	19,8	0.767 ÷ 0.846	19,5 ÷ 21,5	<b>G11J-9</b>			
		13	0.095	2,41	0.810	20,6	0.827 ÷ 0.906	21,0 ÷ 23,0	<b>G11J-9/A</b>			
		14	0.083	2,11	0.834	21,2	0.866 ÷ 0.945	22,0 ÷ 24,0	<b>G11J-10</b>			
		15	0.072	1,83	0.856	21,7	0.925 ÷ 1.004	23,5 ÷ 25,5	<b>G11J-11</b>			
		16	0.065	1,65	0.870	22,1						
		18	0.049	1,24	0.902	22,9						
		19	0.042	1,07	0.916	23,2						
		20	0.035	0,89	0.930	23,6						
		22	0.028	0,71	0.944	24,0						
1.1/4"	(31,8)	10	0.134	3,40	0.982	25,0	0.964 ÷ 1.043	24,5 ÷ 26,5	<b>G11J-12</b>	G11C 12÷15	G11T 8/A÷20	TPC-34
		11	0.120	3,05	1.010	25,7	1.043 ÷ 1.122	26,5 ÷ 28,5	<b>G11J-13</b>			
		12	0.109	2,77	1.032	26,2	1.102 ÷ 1.181	28,0 ÷ 30,0	<b>G11J-14</b>			
		13	0.095	2,41	1.060	27,0	1.161 ÷ 1.240	29,5 ÷ 31,5	<b>G11J-15</b>			
		14	0.083	2,11	1.084	27,6						
		16	0.065	1,65	1.120	28,5						
		18	0.049	1,24	1.152	29,3						
		19	0.042	1,07	1.166	29,6						
1.1/2"	(38,1)	8	0.165	4,19	1.170	29,7	1.161 ÷ 1.240	29,5 ÷ 31,5	<b>G11J-16</b>	G11C 16÷20	G11T 8/A÷20	TPC-41
		10	0.134	3,40	1.232	31,3	1.240 ÷ 1.319	31,5 ÷ 33,5	<b>G11J-17</b>			
		11	0.120	3,05	1.260	32,0	1.299 ÷ 1.378	33,0 ÷ 35,0	<b>G11J-18</b>			
		12	0.109	2,77	1.282	32,5	1.358 ÷ 1.437	34,5 ÷ 36,5	<b>G11J-19</b>			
		13	0.095	2,41	1.310	33,3	1.417 ÷ 1.496	36,0 ÷ 38,0	<b>G11J-20</b>			
		14	0.083	2,11	1.334	33,9						
		15	0.072	1,83	1.356	34,4						
		16	0.065	1,65	1.370	34,8						
		18	0.049	1,24	1.402	35,6						
		19	0.042	1,07	1.416	35,9						
20	0.035	0,89	1.430	36,3								
22	0.028	0,71	1.444	36,7								

Critical tube dimensions at the limit of extraction capacity for Grippul 11 (10,000 kg / 22,000 lb)  
It depends on the tube material and on the expansion (tube sheet with or without grooves, length of expansion and expansion level)



# Grippul 21

## Tool table

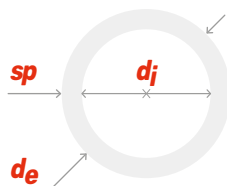

Tube			Espansion		Jaw	Cone	Tie-rod	Collar			
$d_e$		$sp$	$d_j$								
inches	mm	B.W.G	inches	mm	inches	mm	Cod.	Cod.	Cod.		
3/4" (19,0)	12	0,109	2,77	0,532	13,4	0,531 ÷ 0,610	13,5 ÷ 15,5	G11J-2/A	G11C 2/A÷8	G21T 2/A÷8	TPC-21
	13	0,095	2,41	0,560	14,2						
	14	0,083	2,11	0,584	14,8	0,571 ÷ 0,650	14,5 ÷ 16,5	G11J-3			
	15	0,072	1,83	0,606	15,3						
	16	0,065	1,65	0,620	15,7	0,610 ÷ 0,689	15,5 ÷ 17,5	G11J-4			
	18	0,049	1,24	0,652	16,5						
	19	0,042	1,07	0,666	16,8	0,669 ÷ 0,748	17,0 ÷ 19,0	G11J-5			
	20	0,035	0,89	0,680	17,2						
22	0,028	0,71	0,694	17,6							
7/8" (22,2)	12	0,109	2,77	0,657	16,6	0,650 ÷ 0,728	16,5 ÷ 18,5	G11J-6	G11C 2/A÷8	G21T 2/A÷8	TPC-25
	14	0,083	2,11	0,709	18,0						
	16	0,065	1,65	0,745	18,9	0,728 ÷ 0,807	18,5 ÷ 20,5	G11J-7			
	18	0,049	1,24	0,777	19,7						
	19	0,042	1,07	0,791	20,0	0,787 ÷ 0,866	20,0 ÷ 22,0	G11J-8			
	20	0,035	0,89	0,805	20,4						
22	0,028	0,71	0,819	20,8							
1" (25,4)	10	0,134	3,40	0,732	18,6	0,728 ÷ 0,846	18,5 ÷ 21,5	G21J-8/A	G21C 8/A÷11	G21T 8/A÷11	TPC-28
	12	0,109	2,77	0,782	19,8	0,768 ÷ 0,886	19,5 ÷ 22,5	G2J-9			
	13	0,095	2,41	0,810	20,6						
	14	0,083	2,11	0,834	21,2	0,827 ÷ 0,945	21,0 ÷ 24,0	G21J-9/A			
	15	0,072	1,83	0,856	21,7						
	16	0,065	1,65	0,870	22,1	0,866 ÷ 0,984	22,0 ÷ 24,0	G21J-10			
	18	0,049	1,24	0,902	22,9						
	19	0,042	1,07	0,916	23,2	0,925 ÷ 1,043	23,5 ÷ 26,5	G21J-11			
	20	0,035	0,89	0,930	23,6						
22	0,028	0,71	0,944	24,0							
1.1/4" (31,8)	10	0,134	3,40	0,982	25,0	0,965 ÷ 1,083	24,5 ÷ 27,5	G21J-12	G21C 12÷15	G21T 12÷15	TPC-34
	11	0,120	3,05	1,010	25,7						
	12	0,109	2,77	1,032	26,2	1,043 ÷ 1,161	26,5 ÷ 29,5	G21J-13			
	13	0,095	2,41	1,060	27,0						
	14	0,083	2,11	1,084	27,6	1,102 ÷ 1,220	28,0 ÷ 31,0	G21J-14			
	16	0,065	1,65	1,120	28,5						
	18	0,049	1,24	1,152	29,3	1,161 ÷ 1,280	29,5 ÷ 32,5	G21J-15			
	19	0,042	1,07	1,166	29,6						
20	0,035	0,89	1,180	30,0							
22	0,028	0,71	1,194	30,4							

Dimensioni critiche dei tubi al limite della capacità di estrazione del Grippul 21 (20000 Kg / 44000 lb)  
Dipende dal materiale del tubo e dall'espansione ( con o senza canalini nella piastra tubiera, lunghezza dell'espansione e livello di espansione )

Tube			Expansion			Jaw			Cone			Tie-rod			Collar		
$d_e$		B.W.G	$sp$		$d_j$												
inches	mm		inches	mm	inches	mm	inches	mm	Cod.	Cod.	Cod.	Cod.	Cod.	Cod.	Cod.		
1.1/2" (38,1)	8	0.165	4,19	1.170	29,7	1.161 ÷ 1.280	29,5 ÷ 32,5	<b>G21J-16</b>									
	10	0.134	3,40	1.232	31,3												
	11	0.120	3,05	1.260	32,0	1.240 ÷ 1.358	31,5 ÷ 34,5	<b>G21J-17</b>									
	12	0.109	2,77	1.282	32,5												
	13	0.095	2,41	1.310	33,3												
	14	0.083	2,11	1.334	33,9	1.299 ÷ 1.417	33,0 ÷ 36,0	<b>G21J-18</b>	<b>G21C 16÷20</b>	<b>G21T 16÷20</b>	<b>TPC-41</b>						
	15	0.072	1,83	1.356	34,4												
	16	0.065	1,65	1.370	34,8												
	18	0.049	1,24	1.402	35,6	1.358 ÷ 1.476	34,5 ÷ 37,5	<b>G21J-19</b>									
	19	0.042	1,07	1.416	35,9												
20	0.035	0,89	1.430	36,3	1.417 ÷ 1.535	36,0 ÷ 39,0	<b>G21J-20</b>										
22	0.028	0,71	1.444	36,7													
1.3/4" (44,4)	10	0.134	3,40	0.482	37,6	1.476 ÷ 1.594	37,5 ÷ 40,5	<b>G21J-21</b>									
	11	0.120	3,05	1.510	38,3												
	12	0.109	2,77	1.532	38,8												
	14	0.083	2,11	1.584	40,2												
	15	0.072	1,83	1.606	40,7	1.555 ÷ 1.673	39,5 ÷ 42,5	<b>G21J-22</b>	<b>G21C 21÷26</b>	<b>G21T 21÷26</b>	<b>G21TPC-48</b>						
	16	0.065	1,65	1.620	41,1												
	18	0.049	1,24	1.652	41,9												
	19	0.042	1,07	1.666	42,2	1.634 ÷ 1.752	41,5 ÷ 44,5	<b>G21J-23</b>									
20	0.035	0,89	1.680	42,6													
2" (50,8)	10	0.134	3,40	1.732	44,0	1.713 ÷ 1.831	43,5 ÷ 46,5	<b>G21J-24</b>									
	12	0.109	2,77	1.782	45,2												
	13	0.095	2,41	1.810	46,0	1.791 ÷ 1.909	45,5 ÷ 48,5	<b>G21J-25</b>	<b>G21C 21÷26</b>	<b>G21T 21÷26</b>	<b>G21TPC-54</b>						
	14	0.083	2,11	1.834	46,6												
	16	0.065	1,65	1.870	47,5												
	18	0.049	1,24	1.884	47,8	1.870 ÷ 1.988	47,5 ÷ 50,5	<b>G21J-26</b>									
2.1/2" (63,5)	3	0.259	6,58	1.982	50,3	1.968 ÷ 2.087	50,0 ÷ 53,0	<b>G21J-27</b>									
	4	0.238	6,05	2.024	51,4												
	5	0.220	5,59	2.060	52,3	2.067 ÷ 2.185	52,5 ÷ 55,5	<b>G21J-28</b>									
	6	0.203	5,16	2.094	53,2												
	7	0.180	4,57	2.140	54,3	2.146 ÷ 2.205	54,5 ÷ 57,5	<b>G21J-29</b>									
	9	0.148	4,76	2.204	56,0												
	10	0.134	3,40	2.232	56,7												
	11	0.120	3,05	2.260	57,4	2.224 ÷ 2.343	56,5 ÷ 59,5	<b>G21J-30</b>	<b>G21C 27÷32</b>	<b>G21T 27÷32</b>	<b>G21TPC-68</b>						
	12	0.109	2,77	2.282	57,9												
	14	0.083	2,11	2.334	59,3												
15	0.072	1,83	2.356	59,8	2.303 ÷ 2.421	58,5 ÷ 61,5	<b>G21J-31</b>										
16	0.065	1,65	2.370	60,2													
18	0.049	1,24	2.402	61,0	2.382 ÷ 2.500	60,5 ÷ 63,5	<b>G21J-32</b>										

Dimensioni critiche dei tubi al limite della capacità di estrazione del Grippul 21 ( 20000 Kg / 44000 lb )  
 Dipende dal materiale del tubo e dall'espansione ( con o senza canalini nella piastra tubiera, lunghezza dell'espansione e livello di espansione )



ATTENZIONE: ESPLOSIONE PER  
L'USO DI LIQUIDI E GAS PRESSURIZZATI. LEGGERE LE ISTRUZIONI.  
NON TOCCARE LE PARTI CALDE. NON STARE DENTRO LA MANICATA.

ITALIA



# *Runpul*

*Automatic continuous hydraulic tube puller*

# Runpul

*Automatic hydraulic tube puller  
for the continuous high-speed extraction of tubes*

Maus Italia automatic hydraulic tube pullers are the result of more than forty years of experience in the field of tube extraction. Runpul is designed and manufactured for fast and continuous extraction.

Runpul comes in an electrically or pneumatically operated version. It is equipped with an incorporated remote control and comes in four versions depending on the extraction force ( Runpul 15, Runpul 30, Runpul 45 and Runpul 60 ).



## **Automatic**

Exclusive double-jaw system



## **High speed**

For large-scale maintenance operations



## **High quality**

Preserving the tube sheet hole

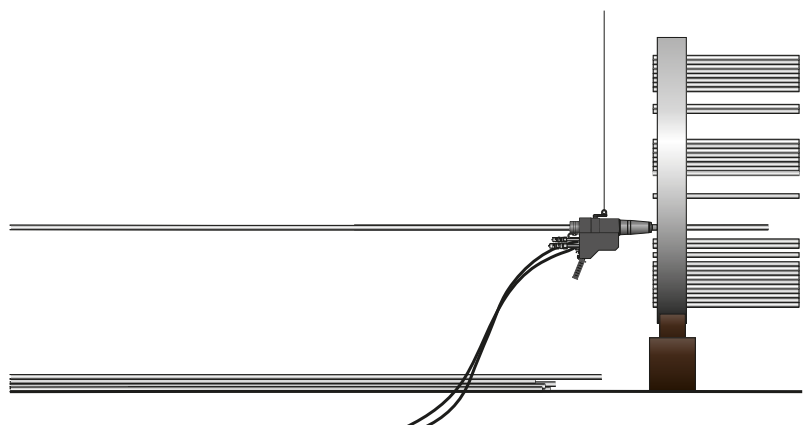

## The extraction process

The extraction process consists of the following steps:

- Select the correct tools (TPC thrust collar, TPJ tightening jaws and TPM extraction mandrel) according to the dimensions of the tube to be extracted
- Install the TPC thrust collar and TPJ tightening jaws onto the RUNPUL hydraulic puller
- Screw the TPM extraction mandrel into the tube inlet using the TPA pneumatic Impact wrench and TPS reduction coupling ( Pic. A)
- Position the RUNPUL hydraulic puller onto the TPM extraction mandrel until the TPC collar is in contact with the tube plate ( Pic. B)
- Proceed with the tube extraction. In the first extraction phase, the TPJ jaws will clamp the TPM mandrel ( Fig. C )
- In the following steps, the TPJ extraction jaws will clamp the tube until it is fully extracted ( Fig. D )  
The operator will select the manual or automated mode - either slow or fast - depending on the condition of both the tube and heat exchanger.

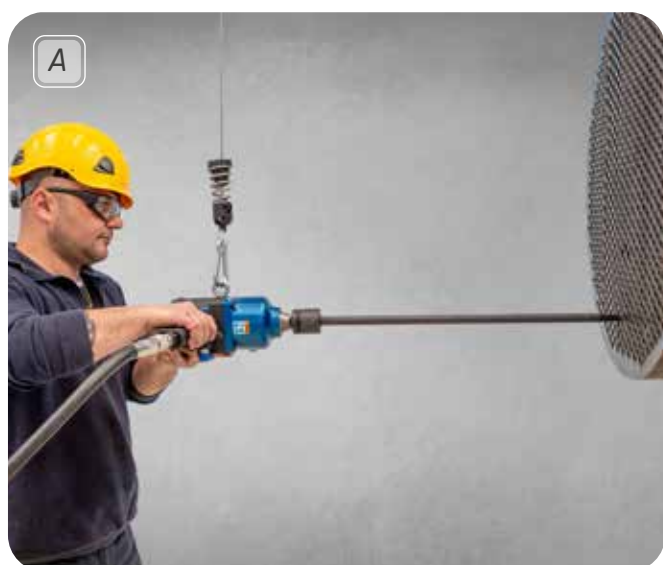



## Features that make the difference



The Unclamping System Device is an emergency system for unlocking jaws that are stuck on the tube in case the Runpul needs to be removed from the tube.



The Over-Pressure Switch cuts off hydraulic oil delivery when the piston reaches the end of its stroke, preventing unnecessary overpressure in the system.

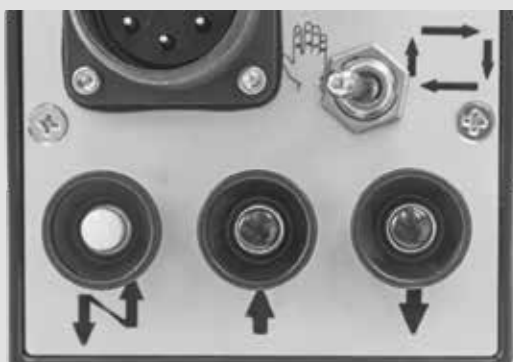

The RC24 remote control beside the knobs simplifies the working steps. In the electric version it is powered at a low voltage of 24 Volts. In its pneumatic version, the control is operated by the air pressure.



The Revolving Support Ring on which RUNPUL is suspended allows optimal positioning in the tightest spaces.

## Unclamping System Device



The Unclamping System Device is an emergency system for unlocking jaws that are stuck on the tube. By turning the selector switch to the 'Jaw release' position located on the control panel of the TP60 HDE or TP30 power unit and simultaneously opening the valve on Runpul, the front jaw is released via an hydraulic cylinder inside Runpul. This operation allows Runpul to be taken out along the tube to be extracted.

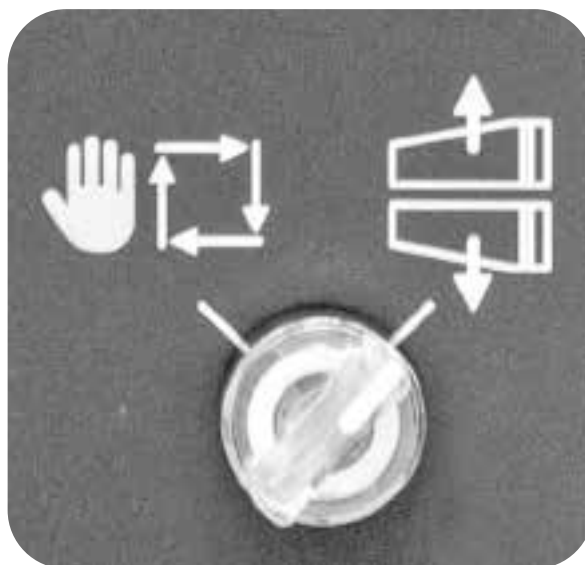

## Easy and friendly commands

### THE RC24 REMOTE CONTROL

The RC24 remote control beside the knobs simplifies the working steps. In the electric version it is powered at a low voltage of 24 Volts.

It includes the following commands:

- Fixed connector to connect the signal cable from Runpul to the hydraulic unit
- 'Manual' / 'Automated' cycle selector switch
- Start/Stop command in case of automated cycle
- Extraction command (in manual mode) or fast extraction (in automated mode)
- Return command (in manual mode)

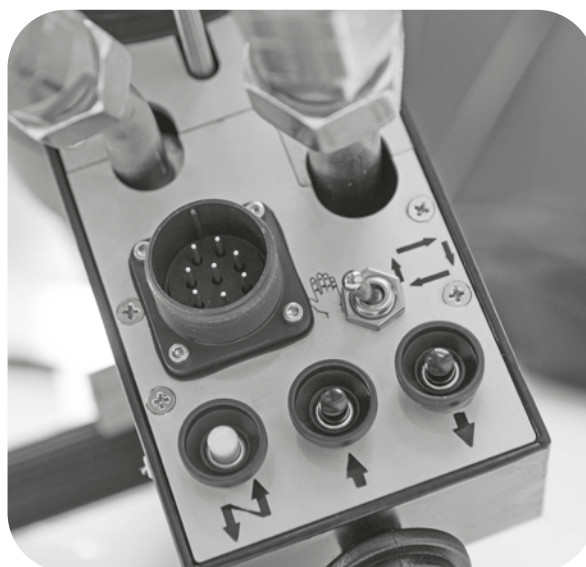

## Over Pressure Switch



The Over-Pressure Switch cuts off hydraulic oil delivery when the piston reaches the end of its stroke, preventing unnecessary overpressure in the system and thus protecting the hydraulic pump.

A rigid shaft mounted on the hydraulic piston via a ring slides into the microswitch holder controlling the interruption of the hydraulic oil supply.

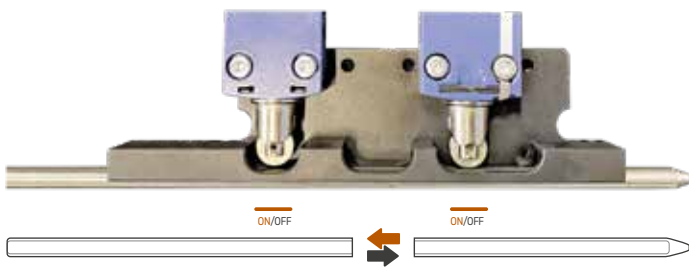

## High Pressure Hydraulic Hoses



High Pressure Hydraulic Hoses are 6 m (19.7 ft) long and certified for use up to 350 bar (5075 psi). They are equipped with FLAT fittings that reduce dripping during connection and disconnection from RUNPUL and hydraulic power unit. They are also equipped with safety systems that prevent a whip effect in the event of a broken hose-fitting connection.





## Power unit coupling

### Runpul EM

The electric version of the Runpul tube extractor can be combined with both the TP60HDE and TP30E PF electric power units

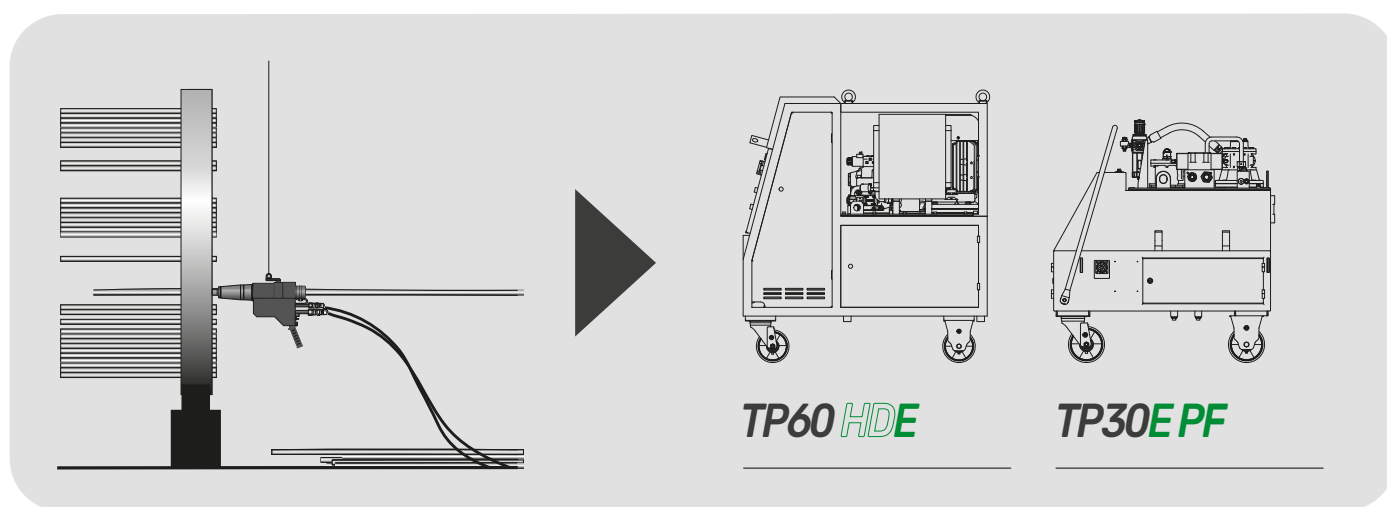

### Runpul PM

The pneumatic version of the Runpul tube extractor can be combined with both the TP60HDP and TP30P PF electric power units

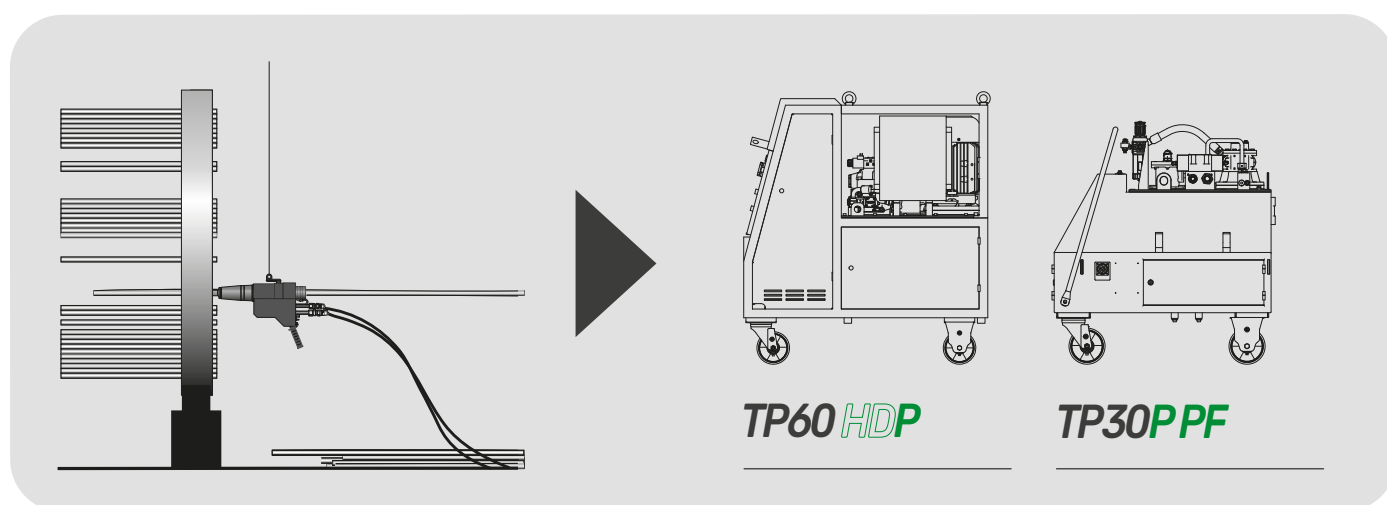

## Electric versions

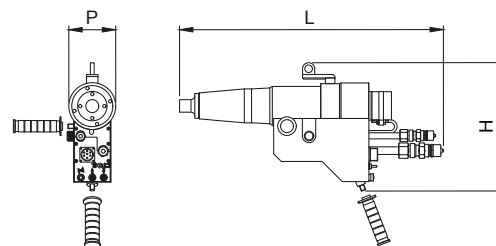

### Runpul 15 EM

- > Tube ( *min* < *de* > *max* )     9,2 ÷ 28,6 mm - 3/8" ÷ 1.1/8"
- > Maximum extraction force            15000 Kg / 33000 lb
- > Stroke                                        101,6 mm / 4"
- > Speed with TP60HDE                    6,2 mt - 244" / min
- > Speed with TP30EPF                    5,0 mt - 197" / min
- > Dimensions:
- Width *L*:                                    690 mm / 27.2"
- Depth *P*:                                    124 mm / 4.9"
- Height *H*:                                   340 mm / 13.4"
- > Remote control supply                    24 V
- > Weight                                        26 Kg / 57.2 lb

### Runpul 30 EM

- > Tube ( *min* < *de* > *max* )     9,5 ÷ 42,4 mm - 3/8" ÷ 1.1/4"GAS
- > Maximum extraction force            30000 Kg / 66000 lb
- > Stroke                                        101,6 mm / 4"
- > Speed with TP60HDE                    4,4 mt - 173" / min
- > Speed with TP30EPF                    3,2 mt - 126" / min
- > Dimensions:
- Width *L*:                                    730 mm / 28.7"
- Depth *P*:                                    155 mm / 6.1"
- Height *H*:                                   430 mm / 16.9"
- > Remote control supply                    24 V
- > Weight                                        46 Kg / 101.2 lb

### Runpul 45 EM

- > Tube ( *min* < *de* > *max* )     25,4 ÷ 76,2 mm - 1" ÷ 3"
- > Maximum extraction force            45000 Kg / 99000 lb
- > Stroke                                        50,8 mm / 2"
- > Speed with TP60HDE                    2,6 mt - 102" / min
- > Speed with TP30EPF                    1,6 mt - 63" / min
- > Dimensions:
- Width *L*:                                    740 mm / 29.1"
- Depth *P*:                                    190 mm / 7.5"
- Height *H*:                                   430 mm / 16.9"
- > Remote control supply                    24 V
- > Weight                                        70 Kg / 154 lb

### Runpul 60 EM

- > Tube ( *min* < *de* > *max* )     50,8 ÷ 101,6 mm - 2" ÷ 4"
- > Maximum extraction force            60000 Kg / 132000 lb
- > Stroke                                        50,8 mm / 2"
- > Speed with TP60HDE                    2,2 mt - 87" / min
- > Speed with TP30EPF                    2,2 mt - 87" / min
- > Dimensions:
- Width *L*:                                    750 mm / 29.5"
- Depth *P*:                                    220 mm / 8.7"
- Height *H*:                                   450 mm / 17.7"
- > Remote control supply                    24 V
- > Weight                                        96 Kg / 211.2 lb

## Pneumatic versions

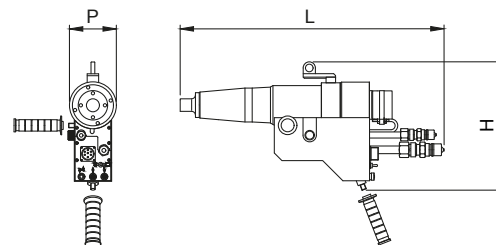

### Runpul 15 PM

- > Tube ( *min* < *de* > *max* ) 9,2 ÷ 28,6 mm - 3/8" ÷ 1.1/8"
- > Maximum extraction force 15000 Kg / 33000 lb
- > Stroke 101,6 mm / 4"
- > Speed with TP60HDP 5,8 mt - 228" / min
- > Speed with TP30PPF 4,6 mt - 181" / min
- > Dimensions:
  - Width *L*: 690 mm / 27.2"
  - Depth *P*: 124 mm / 4.9"
  - Height *H*: 340 mm / 13.4"
- > Remote control power supply 6-7bar
- > Weight 26 Kg / 57.2 lb

### Runpul 30 PM

- > Tube ( *min* < *de* > *max* ) 9,5 ÷ 42,4 mm - 3/8" ÷ 1.1/4"GAS
- > Maximum extraction force 30000 Kg / 66000 lb
- > Stroke 101,6 mm / 4"
- > Speed with TP60HDP 4,2 mt - 165" / min
- > Speed with TP30PPF 3,0 mt - 118" / min
- > Dimensions:
  - Width *L*: 730 mm / 28.7"
  - Depth *P*: 155 mm / 6.1"
  - Height *H*: 430 mm / 16.9"
- > Remote control power supply 6-7bar
- > Weight 46 Kg / 101.2 lb

### Runpul 45 PM

- > Tube ( *min* < *de* > *max* ) 25,4 ÷ 76,2 mm - 1" ÷ 3"
- > Maximum extraction force 45000 Kg / 99000 lb
- > Stroke 50,8 mm / 2"
- > Speed with TP60HDP 2,6 mt - 102" / min
- > Speed with TP30PPF 1,6 mt - 63" / min
- > Dimensions:
  - Width *L*: 740 mm / 29.1"
  - Depth *P*: 190 mm / 7.5"
  - Height *H*: 430 mm / 16.9"
- > Remote control power supply 6-7bar
- > Weight 70 Kg / 154 lb

### Runpul 60 PM

- > Tube ( *min* < *de* > *max* ) 50,8 ÷ 101,6 mm - 2" ÷ 4"
- > Maximum extraction force 60000 Kg / 132000 lb
- > Stroke 50,8 mm / 2"
- > Speed with TP60HDP 2,2 mt - 87" / min
- > Speed with TP30PPF 2,2 mt - 87" / min
- > Dimensions:
  - Width *L*: 750 mm / 29.5"
  - Depth *P*: 220 mm / 8.7"
  - Height *H*: 450 mm / 17.7"
- > Remote control power supply 6-7bar
- > Weight 96 Kg / 211.2 lb



# TP60 HDE

## PLC-controlled Heavy Duty electric hydraulic power unit to be combined with a Runpul series tube extractor



Maximum pressure up to 350 bar ( 5075 psi )

The TP60HDE power unit is characterised by a use under particularly demanding conditions. The upgraded motor, the pump with variable flow rate, the improved oil cooler, the IP55-rated control cabinet, the dedicated software, as well as the accessory and tool housings, make this machine an ideal partner for tube bundle maintenance.



Features in automatic mode



Features in manual mode



Jaws release



Alarm indicators

- > Max pression: 350 bar / 5075 psi
- > Oil flow: 65 Lt/min
- > Hydraulic oil ( not included ): 100 Lt / 27 US gal  
Viscosity 68
- > Supply: 400V 3Ph / 7,5 Kw
- > IP: 55
- > Dimensions:
  - Width: 73 cm / 28,74"
  - Depth: 113 cm / 44,49"
  - Height: 121 cm / 47,64"
- > Weight ( without hydraulic oil ): 320 kg / 705 lb
- > Crate



Width: 124 cm / 48,82"  
 Depth: 88 cm / 34,65"  
 Height: 141 cm / 55,51"  
 Weight of the crate: 98 kg / 216 lb



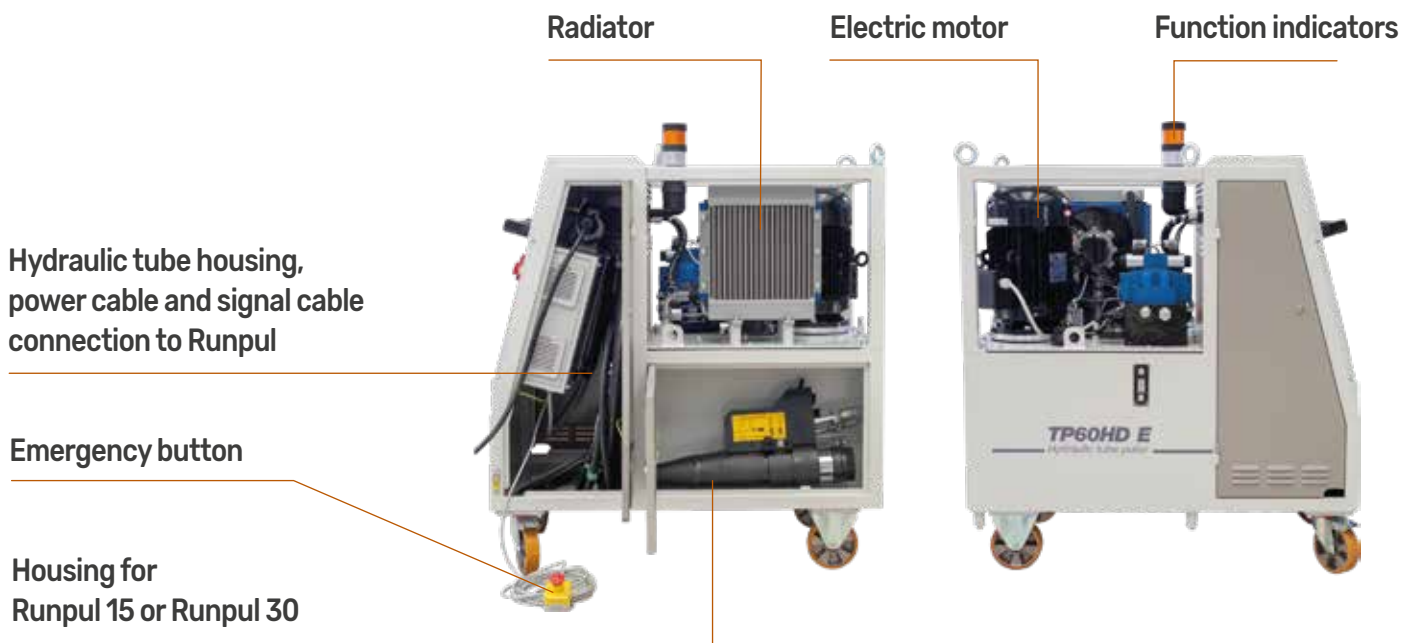

Hydraulic oil filter with electrical signalling for filters to be replaced



Electrovalves in automated / manual cycle (slow/fast)  
Hydraulic oil flow and pressure regulation



End of piston stroke

Manual / automated mode / Jaw release

Hydraulic oil temperature alarm  
Electric motor overheating alarm  
Warning to replace the hydraulic oil filter cartridge

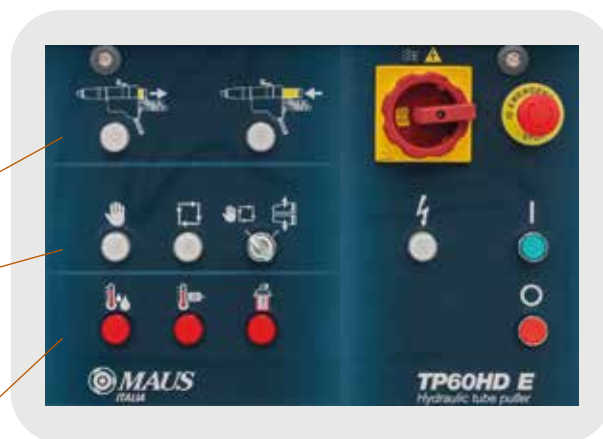

# TP60 HDP

## Heavy Duty pneumatic hydraulic power unit to be combined with a Runpul series tube extractor



Maximum pressure up to 300 bar ( 4350 psi )



Features in automatic mode



Features in manual mode



Alarm indicators

The TP60HDP power unit is characterised by a use under particularly demanding conditions. The upgraded motor, the pump with variable flow rate, the improved oil cooler as well as the accessory and tool housings, make this machine an ideal partner for tube bundle maintenance professionals.

- > Max pressure: 300 bar / 4350 psi
- > Oil flow: 60 Lt/min
- > Hydraulic oil ( not included ): 100 Lt / 27 US gal  
Viscosity 46
- > Motor power: 6,7 Kw
- > Air consumption: 420 m<sup>3</sup>/h @ 7 bar  
245 CFM @ 100 psi
- > Dimensions:
  - Width: 73 cm / 28,74"
  - Depth: 113 cm / 44,49"
  - Height: 121 cm / 47,64"
- > Weight ( without hydraulic oil ): 300 kg / 661 lb
- > Crate



Width: 124 cm / 48,82"  
 Depth: 88 cm / 34,65"  
 Height: 141 cm / 55,51"  
 Weight of the crate: 98 kg / 216 lb







Runpul housing

Housing for hydraulic tubes and cable connection to Runpul

Radiator



Pneumatic motor



Hydraulic oil filter with mechanical indicator for hydraulic oil filter change warning.



# TP30E PF

## Hydraulic electric power unit to be combined with the Runpul series tube extractor



Maximum pressure up to 350 bar ( 5075 psi )



Features in automatic mode



Features in manual mode

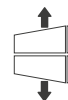

Jaws release

The TP30E PF power unit is designed for both heavy-duty maintenance work and minor maintenance.

Thanks to its low weight and small volume, it is particularly suitable for handling within plants.

- > Max pression: 350 bar / 5075 psi
- > Oil flow: 35 Lt/min
- > Hydraulic oil ( not included ) : 90 Lt / 24 US gal  
Viscosity 46
- > Supply: 400V 3Ph / 4 Kw
- > IP: 20
- > Dimensions:
  - Width: 71 cm / 27,95"
  - Depth: 92 cm / 36,22"
  - Height: 98 cm / 38,58"
- > Weight ( without hydraulic oil ): 228 kg / 48.5 lb
- > Crate



Width: 108 cm / 42,52"  
 Depth: 98 cm / 38,58"  
 Height: 135 cm / 53,15"  
 Weight of the crate: 90 kg / 198 lb





Electric motor

Electrovalve in manual / automated cycle

Runpul housing

Housing for service keys and tools

Hydraulic oil filter with mechanical indicator for hydraulic oil filter change warning.

Control panel

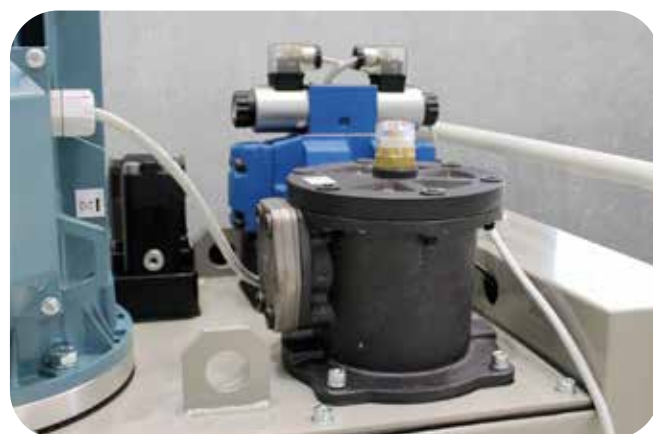

Manual / Automatic mode / Jaw release

End of piston stroke

Motor start



# TP30P PF

## Hydraulic pneumatic power unit to be combined with the Runpul series tube extractor



Maximum pressure up to 350 bar ( 5075 psi )



Features in automatic mode



Features in manual mode

The TP30P PF power unit is designed for both heavy-duty maintenance work and minor maintenance.

Thanks to its low weight and small volume, it is particularly suitable for handling within the plant.

- > Max pressure: 350 bar / 5075 psi
- > Oil flow: 30 Lt/min
- > Hydraulic oil ( not included ) : 90 Lt / 24 US gal  
Viscosity 46
- > Motor power: 3,7 Kw
- > Air consumption: 300 m<sup>3</sup>/h @ 7 bar  
175 CFM @ 100 psi
- > Dimensions:
  - Width: 71 cm / 27,95"
  - Depth: 92 cm / 36,22"
  - Height: 98 cm / 38,58"
- > Weight ( without hydraulic oil ): 146 kg / 322 lb
- > Crate



Width: 108 cm / 42,52"  
 Depth: 98 cm / 38,58"  
 Height: 131 cm / 51,57"  
 Weight of the crate: 90 kg / 198 lb





Housing for service keys and tools.

Hydraulic oil filter with mechanical indicator for oil filter change warning.



Pneumatic valves in manual / automated mode

Pneumatic motor



# TPM

Extraction mandrel for tubes from 3/8" ( 9,5mm ) to 2.1/2" ( 63,5mm )

Tube features				Mandrel <input checked="" type="checkbox"/>	
$d_e$		$sp$	$d_i$		
inches	mm	B.W.G	mm	inches	Cod. In.
<b>3/8"</b> <b>(9,5)</b>	17 ÷ 19	6,5 ÷ 7,5	0.256 ÷ 0.295	<b>TPM-7</b>	5/16"
	20 ÷ 24	7,5 ÷ 8,5	0.295 ÷ 0.335	<b>TPM-8</b>	
<b>1/2"</b> <b>(12,7)</b>	14 ÷ 16	8,5 ÷ 9,5	0.335 ÷ 0.374	<b>TPM-9</b>	3/8"
	17 ÷ 18	9,5 ÷ 10,5	0.374 ÷ 0.413	<b>TPM-10</b>	
	19 ÷ 21	10,5 ÷ 11,5	0.413 ÷ 0.453	<b>TPM-11</b>	
<b>5/8"</b> <b>(15,9)</b>	24	11,5 ÷ 12,5	0.453 ÷ 0.492	<b>TPM-12</b>	1/2"
	12 ÷ 13	10,3 ÷ 11,1	0.407 ÷ 0.435	<b>TPM-11A</b>	
	14 ÷ 15	11,7 ÷ 12,2	0.459 ÷ 0.481	<b>TPM-12A</b>	
	16 ÷ 17	12,5 ÷ 13,5	0.492 ÷ 0.531	<b>TPM-13A</b>	
	19 ÷ 21	13,5 ÷ 14,5	0.531 ÷ 0.571	<b>TPM-14A</b>	
<b>3/4"</b> <b>(19,0)</b>	23 ÷ 24	14,5 ÷ 15,5	0.571 ÷ 0.610	<b>TPM-15A</b>	5/8"
	11	12,5 ÷ 13,5	0.492 ÷ 0.531	<b>TPM-13</b>	
	12 ÷ 13	13,5 ÷ 14,5	0.531 ÷ 0.571	<b>TPM-14</b>	
	14 ÷ 15	14,5 ÷ 15,5	0.571 ÷ 0.610	<b>TPM-15</b>	
	16 ÷ 17	15,5 ÷ 16,5	0.610 ÷ 0.650	<b>TPM-16</b>	
	18 ÷ 20	16,5 ÷ 17,5	0.650 ÷ 0.689	<b>TPM-17</b>	
<b>7/8"</b> <b>(22,2)</b>	21 ÷ 24	17,5 ÷ 18,5	0.689 ÷ 0.728	<b>TPM-18</b>	5/8"
	14	17,5 ÷ 18,5	0.689 ÷ 0.728	<b>TPM-18S</b>	
	16 ÷ 17	18,5 ÷ 19,5	0.728 ÷ 0.768	<b>TPM-19S</b>	
	18 ÷ 19	19,5 ÷ 20,5	0.768 ÷ 0.807	<b>TPM-20S</b>	
<b>1"</b> <b>(25,4)</b>	10 ÷ 11	18,5 ÷ 19,5	0.728 ÷ 0.768	<b>TPM-19</b>	3/4"
	12	19,5 ÷ 20,5	0.768 ÷ 0.807	<b>TPM-20</b>	
	13 ÷ 14	20,5 ÷ 21,5	0.807 ÷ 0.846	<b>TPM-21</b>	
	15 ÷ 16	21,5 ÷ 22,5	0.846 ÷ 0.886	<b>TPM-22</b>	
	18	22,5 ÷ 23,5	0.886 ÷ 0.925	<b>TPM-23</b>	
	19 ÷ 20	23,5 ÷ 24,5	0.925 ÷ 0.965	<b>TPM-24</b>	
<b>3/4" Gas</b> <b>(26,9)</b>	13	21,5 ÷ 22,5	0.846 ÷ 0.886	<b>TPM-22G</b>	3/4"
	14 ÷ 15	22,5 ÷ 23,5	0.886 ÷ 0.925	<b>TPM-23G</b>	
	16 ÷ 17	23,5 ÷ 24,5	0.925 ÷ 0.965	<b>TPM-24G</b>	
<b>1.1/4"</b> <b>(31,8)</b>	19 ÷ 21	24,5 ÷ 25,4	0.956 ÷ 1.004	<b>TPM-25G</b>	1"
	10	24,5 ÷ 25,4	0.956 ÷ 1.004	<b>TPM-25</b>	
	11 ÷ 12	25,5 ÷ 26,5	1.004 ÷ 1.043	<b>TPM-26</b>	
	13	26,5 ÷ 27,5	1.043 ÷ 1.083	<b>TPM-27</b>	
	14 ÷ 15	27,5 ÷ 28,5	1.083 ÷ 1.112	<b>TPM-28</b>	
	16 ÷ 18	28,5 ÷ 29,5	1.112 ÷ 1.161	<b>TPM-29</b>	
	19 ÷ 22	29,5 ÷ 30,5	1.161 ÷ 1.201	<b>TPM-30</b>	
	23 ÷ 24	30,5 ÷ 31,5	1.201 ÷ 1.240	<b>TPM-31</b>	
<b>1" Gas</b> <b>(33,7)</b>	9	25,5 ÷ 26,5	1.004 ÷ 1.043	<b>TPM-26G</b>	1"
	10	26,5 ÷ 27,5	1.043 ÷ 1.063	<b>TPM-27G</b>	
	11	27,5 ÷ 28,5	1.083 ÷ 1.122	<b>TPM-28G</b>	
	13 ÷ 14	28,5 ÷ 29,5	1.122 ÷ 1.161	<b>TPM-29G</b>	

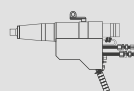
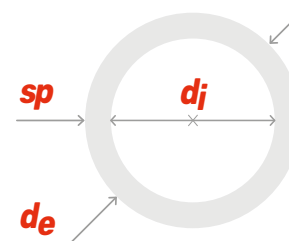

Dimensions fit for

**Runpul 15**

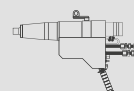

Dimensions fit for

**Runpul 30**

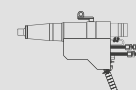

Dimensions fit for

**Runpul 45**





Tube features				Mandrel <input checked="" type="checkbox"/>	
$d_e$		$sp$	$d_j$		
inches	mm	B.W.G	mm	inches	Cod. In.
<b>1.1/2"</b> <b>(38,1)</b>	10 ÷ 11	31,5 ÷ 32,5	1.240 ÷ 1.280	<b>TPM-32</b>	1"
	12 ÷ 13	32,5 ÷ 33,5	1.280 ÷ 1.319	<b>TPM-33</b>	
	14	33,5 ÷ 34,5	1.319 ÷ 1.358	<b>TPM-34</b>	
	15 ÷ 17	34,5 ÷ 35,5	1.358 ÷ 1.398	<b>TPM-35</b>	
	18 ÷ 20	35,5 ÷ 36,5	1.398 ÷ 1.437	<b>TPM-36</b>	
	21 ÷ 24	36,5 ÷ 37,5	1.437 ÷ 1.280	<b>TPM-37</b>	
<b>1.1/4" Gas</b> <b>(42,4)</b>	12	36,5 ÷ 37,5	1.437 ÷ 1.476	<b>TPM-37G</b>	1"
	15 ÷ 16	37,5 ÷ 38,5	1.476 ÷ 1.516	<b>TPM-38G</b>	
	14 ÷ 16	38,5 ÷ 39,5	1.516 ÷ 1.555	<b>TPM-39G</b>	
	17 ÷ 19	39,5 ÷ 40,5	1.555 ÷ 1.594	<b>TPM-40G</b>	
	20 ÷ 24	40,5 ÷ 41,5	1.594 ÷ 1.634	<b>TPM-41G</b>	
<b>1.3/4"</b> <b>(44,4)</b>	10 ÷ 11	37,5 ÷ 38,5	1.476 ÷ 1.516	<b>TPM-38/44</b>	1"
	12	38,5 ÷ 39,5	1.516 ÷ 1.555	<b>TPM-39/44</b>	
	13 ÷ 14	39,5 ÷ 40,5	1.555 ÷ 1.594	<b>TPM-40/44</b>	
	15 ÷ 16	40,5 ÷ 41,5	1.594 ÷ 1.634	<b>TPM-41/44</b>	
	18 ÷ 19	41,5 ÷ 42,5	1.634 ÷ 1.673	<b>TPM-42/44</b>	
	20 ÷ 24	42,5 ÷ 43,5	1.673 ÷ 1.713	<b>TPM-43/44</b>	
<b>1.1/2" Gas</b> <b>(48,3)</b>	11 ÷ 12	42,5 ÷ 43,5	1.673 ÷ 1.713	<b>TPM-43G</b>	1"
	13 ÷ 14	43,5 ÷ 44,5	1.713 ÷ 1.752	<b>TPM-44G</b>	
	15 ÷ 17	44,5 ÷ 45,5	1.752 ÷ 1.791	<b>TPM-45G</b>	
	18 ÷ 19	45,5 ÷ 43,5	1.791 ÷ 1.831	<b>TPM-46G</b>	
<b>2"</b> <b>(50,8)</b>	10	43,5 ÷ 44,5	1.713 ÷ 1.752	<b>TPM-44/51</b>	1"
	11 ÷ 12	44,5 ÷ 45,5	1.752 ÷ 1.791	<b>TPM-45/51</b>	
	13	45,5 ÷ 46,5	1.791 ÷ 1.831	<b>TPM-46/51</b>	
	14 ÷ 15	46,5 ÷ 47,5	1.831 ÷ 1.870	<b>TPM-47/51</b>	
	16 ÷ 18	47,5 ÷ 48,5	1.870 ÷ 1.909	<b>TPM-48/51</b>	
	19 ÷ 22	48,5 ÷ 21,5	1.909 ÷ 1.949	<b>TPM-49/51</b>	
	9 ÷ 10	49,5 ÷ 50,5	1.949 ÷ 1.985	<b>TPM-50/57</b>	
<b>2.1/4"</b> <b>(57,1)</b>	11	50,5 ÷ 51,5	1.985 ÷ 1.476	<b>TPM-51/57</b>	1.1/2"
	12 ÷ 13	51,5 ÷ 52,5	2.028 ÷ 2.067	<b>TPM-52/57</b>	
	7	50,5 ÷ 51,5	1.999 ÷ 2.029	<b>TPM-51G</b>	
<b>2" Gas</b> <b>(60,3)</b>	8	51,5 ÷ 52,5	2.028 ÷ 2.057	<b>TPM-52G</b>	1.1/2"
	9	52,5 ÷ 53,5	2.067 ÷ 2.105	<b>TPM-53G</b>	
	7	53,5 ÷ 54,4	2.105 ÷ 2.145	<b>TPM-54/63</b>	
<b>2.1/2"</b> <b>(63,5)</b>	8	54,5 ÷ 55,4	2.145 ÷ 2.185	<b>TPM-55/63</b>	1.1/2"
	9	55,5 ÷ 56,5	2.185 ÷ 2.224	<b>TPM-56/63</b>	
	10	56,5 ÷ 57,5	2.224 ÷ 2.264	<b>TPM-57/63</b>	

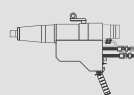
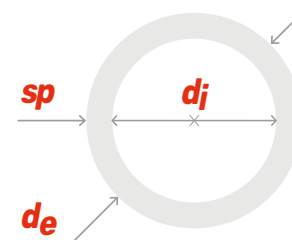

Dimensions fit for

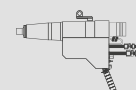
**Runpul 30**

Dimensions fit for

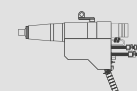
**Runpul 45**

Dimensions fit for

**Runpul 60**

## Jaws TPJ



<b>de</b>	<b>Runpul 15</b>	<b>Runpul 30</b>	<b>Runpul 45</b>	<b>Runpul 60</b>
inches	Cod.	Cod.	Cod.	Cod.
3/8"	Set-TPJ/15-1	Set-TPJ/30-1	-	-
1/2"	Set-TPJ/15-2	Set-TPJ/30-2	-	-
5/8"	Set-TPJ/15-3	Set-TPJ/30-3	-	-
3/4"	Set-TPJ/15-4	Set-TPJ/30-4	-	-
7/8"	Set-TPJ/15-4/A	Set-TPJ/30-4/A	-	-
1"	Set-TPJ/15-5	Set-TPJ/30-5	Set-TPJ/45-5	-
3/4" Gas	-	Set-TPJ/30-6	Set-TPJ/45-6	-
1.1/4"	-	Set-TPJ/30-7	Set-TPJ/45-7	-
1" Gas	-	Set-TPJ/30-8	Set-TPJ/45-8	-
1.1/2"	-	Set-TPJ/30-9	Set-TPJ/45-9	-
1.1/4" Gas	-	Set-TPJ/30-10	Set-TPJ/45-10	-
1.3/4"	-	-	Set-TPJ/45-11	-
1.1/2" Gas	-	-	Set-TPJ/45-12	-
2"	-	-	Set-TPJ/45-13	Set-TPJ/60-13
2.1/4"	-	-	Set-TPJ/45-14	Set-TPJ/60-14
2" Gas	-	-	Set-TPJ/45-15	Set-TPJ/60-15
2.1/2"	-	-	Set-TPJ/45-16	Set-TPJ/60-16
3"	-	-	Set-TPJ/45-17	Set-TPJ/60-17
3.1/2"	-	-	-	Set-TPJ/60-18
4"	-	-	-	Set-TPJ/60-19

## TPC Collars



<b>de</b>	<b>Runpul 15</b>	<b>Runpul 30</b>	<b>Runpul 45</b>	<b>Runpul 60</b>
inches	Cod.	Cod.	Cod.	Cod.
3/8"	TPC-11	TPC-11	-	-
1/2"	TPC-14	TPC-14	-	-
5/8"	TPC-18	TPC-18	-	-
3/4"	TPC-21	TPC-21	-	-
7/8"	TPC-25	TPC-25	-	-
1"	TPC-28	TPC-28	TPC-28	-
3/4" Gas	-	TPC-31	TPC-31	-
1.1/4"	-	TPC-34	TPC-34	-
1" Gas	-	TPC-37	TPC-37	-
1.1/2"	-	TPC-41	TPC-41	-
1.1/4" Gas	-	TPC-44	TPC-44	-
1.3/4"	-	-	TPC/45-48	-
1.1/2" Gas	-	-	TPC/45-53	-
2"	-	-	TPC/45-56	TPC/60-56
2.1/4"	-	-	TPC/45-60	TPC/60-60
2" Gas	-	-	TPC/45-63	TPC/60-63
2.1/2"	-	-	TPC/45-66	TPC/60-66
3"	-	-	TPC/45-80	TPC/60-80
3.1/2"	-	-	-	TPC/60-93
4"	-	-	-	TPC/60-105

# TPM-K



Quick gripping extraction mandrel for tubes from 38,1 mm ( 1.1/2" ) to 101,6 mm ( 4" ).

An exclusive Maus Italia-designed extraction spear: used in combination with the Runpul puller allows for a rapid tube extraction without the need for tightening with a screwer ( no screwer or specific keys required ).

Tube				Mandrel	Cone	Jaw	Extension		
<i>d<sub>e</sub></i>		<i>sp</i>	<i>d<sub>j</sub></i>						
inches	mm	B.W.G	mm	inches	Cod.	Inches / mm	Cod.	Cod.	
<b>1.1/2"</b> <b>(38,1)</b>	10 ÷ 11		31,5 ÷ 32,5	1.240 ÷ 1.280	<b>TPM-K-32</b>	CK-32÷37	<b>JK-32</b>	RK-32÷37	1.1/4"
	12 ÷ 13		32,5 ÷ 33,5	1.280 ÷ 1.319	<b>TPM-K-33</b>		<b>JK-33</b>		
	14		33,5 ÷ 34,5	1.319 ÷ 1.358	<b>TPM-K-34</b>		<b>JK-34</b>		
	15 ÷ 17		34,5 ÷ 35,5	1.358 ÷ 1.397	<b>TPM-K-35</b>		<b>JK-35</b>		
	18 ÷ 20		35,5 ÷ 36,5	1.397 ÷ 1.437	<b>TPM-K-36</b>		<b>JK-36</b>		
	21 ÷ 24		36,5 ÷ 37,5	1.437 ÷ 1.476	<b>TPM-K-37</b>		<b>JK-37</b>		
<b>1.3/4"</b> <b>(44,4)</b>	10 ÷ 11		37,5 ÷ 38,5	1.476 ÷ 1.516	<b>TPM-K-38</b>	CK-38÷43	<b>JK-38</b>	RK-38÷43	1.1/4"
	12		38,5 ÷ 39,5	1.516 ÷ 1.555	<b>TPM-K-39</b>		<b>JK-39</b>		
	13 ÷ 14		39,5 ÷ 40,5	1.555 ÷ 1.594	<b>TPM-K-40</b>		<b>JK-40</b>		
	15 ÷ 16		40,5 ÷ 41,5	1.594 ÷ 1.673	<b>TPM-K-41</b>		<b>JK-41</b>		
	18 ÷ 19		41,5 ÷ 42,5	1.634 ÷ 1.673	<b>TPM-K-42</b>		<b>JK-42</b>		
	20 ÷ 24		42,5 ÷ 43,5	1.673 ÷ 1.713	<b>TPM-K-43</b>		<b>JK-43</b>		
<b>2"</b> <b>(50,8)</b>	10		43,5 ÷ 44,5	1.713 ÷ 1.752	<b>TPM-K-44</b>	CK-44÷49	<b>JK-44</b>	RK-44÷49	1.1/4"
	11 ÷ 12		44,5 ÷ 45,5	1.752 ÷ 1.791	<b>TPM-K-45</b>		<b>JK-45</b>		
	13		45,5 ÷ 46,5	1.791 ÷ 1.831	<b>TPM-K-46</b>		<b>JK-46</b>		
	14 ÷ 15		46,5 ÷ 47,5	1.831 ÷ 1.870	<b>TPM-K-47</b>		<b>JK-47</b>		
	16 ÷ 18		47,5 ÷ 48,5	1.870 ÷ 1.909	<b>TPM-K-48</b>		<b>JK-48</b>		
	19 ÷ 22		48,5 ÷ 49,5	1.909 ÷ 1.949	<b>TPM-K-49</b>		<b>JK-49</b>		
<b>2.1/4"</b> <b>(57,1)</b>	9 ÷ 10		49,5 ÷ 50,5	1.949 ÷ 1.988	<b>TPM-K-50</b>	CK-50÷52	<b>JK-50</b>	RK-50÷52	1.1/2"
	11		50,5 ÷ 51,5	1.988 ÷ 2.028	<b>TPM-K-51</b>		<b>JK-51</b>		
	12 ÷ 13		51,5 ÷ 52,5	2.028 ÷ 2.067	<b>TPM-K-52</b>		<b>JK-52</b>		
<b>2.1/2"</b> <b>(63,5)</b>	7		53,5 ÷ 54,5	2.106 ÷ 2.146	<b>TPM-K-54</b>	CK-54÷57	<b>JK-54</b>	RK-54÷57	1.1/2"
	8		54,5 ÷ 55,5	2.146 ÷ 2.185	<b>TPM-K-55</b>		<b>JK-55</b>		
	9		55,5 ÷ 56,5	2.185 ÷ 2.224	<b>TPM-K-56</b>		<b>JK-56</b>		
	10		56,5 ÷ 57,5	2.224 ÷ 2.264	<b>TPM-K-57</b>		<b>JK-57</b>		
<b>3"</b> <b>(76,2)</b>	7		66,5 ÷ 67,5	2.618 ÷ 2.667	<b>TPM-K-67</b>	CK-67÷70	<b>JK-67</b>	RK-67÷70	1.3/4"
	8		67,5 ÷ 68,5	2.657 ÷ 2.697	<b>TPM-K-68</b>		<b>JK-68</b>		
	9 ÷ 10		68,5 ÷ 69,5	2.697 ÷ 2.736	<b>TPM-K-69</b>		<b>JK-69</b>		
	11		69,5 ÷ 70,5	2.736 ÷ 2.776	<b>TPM-K-70</b>		<b>JK-70</b>		
<b>3.1/2"</b> <b>(88,9)</b>	6		78,5 ÷ 79,5	3.091 ÷ 3.130	<b>TPM-K-79</b>	CK-79÷82	<b>JK-79</b>	RK-79÷82	1.3/4"
	7		79,5 ÷ 80,5	3.130 ÷ 3.169	<b>TPM-K-80</b>		<b>JK-80</b>		
	8 ÷ 9		80,5 ÷ 81,5	3.169 ÷ 3.209	<b>TPM-K-81</b>		<b>JK-81</b>		
	10		81,5 ÷ 82,5	3.209 ÷ 3.248	<b>TPM-K-82</b>		<b>JK-82</b>		
<b>4"</b> <b>(101,6)</b>	6		91,5 ÷ 92,5	3.602 ÷ 3.642	<b>TPM-K-92</b>	CK-92÷95	<b>JK-92</b>	RK-92÷95	1.3/4"
	7 ÷ 8		92,5 ÷ 93,5	3.642 ÷ 3.681	<b>TPM-K-93</b>		<b>JK-93</b>		
	9		93,5 ÷ 94,5	3.681 ÷ 3.720	<b>TPM-K-94</b>		<b>JK-94</b>		
	10		94,5 ÷ 95,5	3.720 ÷ 3.760	<b>TPM-K-95</b>		<b>JK-95</b>		



## Accessories

All the accessories offered by Maus Italia to support the Runpul series tube extraction equipment.

### TPA

#### Pneumatic impact wrench

Pneumatic impact wrench for quick and safe insertion of the TPM spear before each extraction. The TPA screwdriver is supplied in a practical and handy carrying case complete with connecting tubes and service keys.



Model	TPM	Working pressure		Air connect	A	Weight	
		bar	Psi			Kg	Lb
TPA 1	TPM 7 ÷ TPM 15 A	6,3	91.4	3/8" Gas	3/4"	5	10.8
TPA 2	TPM 13 ÷ TPM 20 S	6,3	91.4	1/2" Gas	1"	6,3	13.8
TPA 3A	TPM 19 ÷ TPM 37	6,3	91.4	1/2" Gas	1"	9,3	20.6
TPA 4	TPM 37 G ÷ TPM 49/51	6,3	91.4	1/2" Gas	1"	15,0	32.9
TPA 5	TPM 50/57 ÷ TPM 57/63	6,3	91.4	3/4" Gas	1.1/2"	32,0	70.55

### TPS

#### Adapter

Adapter between the TPA impact wrench and the TPM spear to be mounted, available in different sizes as required.



Model	TPA	TPM
	A	B
TPS 1B	3/4"	5/16"
TPS 2B	3/4"	3/8"
TPS 3B	3/4"	1/2"
TPS 3A	1"	1/2"
TPS 4	1"	5/8"
TPS 5	1"	3/4"
TPS 6	1"	1"
TPS 6A	1"	1.1/2"
TPS 7	1.1/2"	1"
TPS 8	1.1/2"	1.1/2"

### TPB

#### Balancer

Model	Balancers	Range
Runpul 15	TPB15	25-30 Kg / 55-66 lb
Runpul 30	TPB30	45-55 Kg / 99-121 lb
Runpul 45	TPB55	75-90 Kg / 165-198 lb
Runpul 60	TPB60	100-120 Kg / 220-265 lb



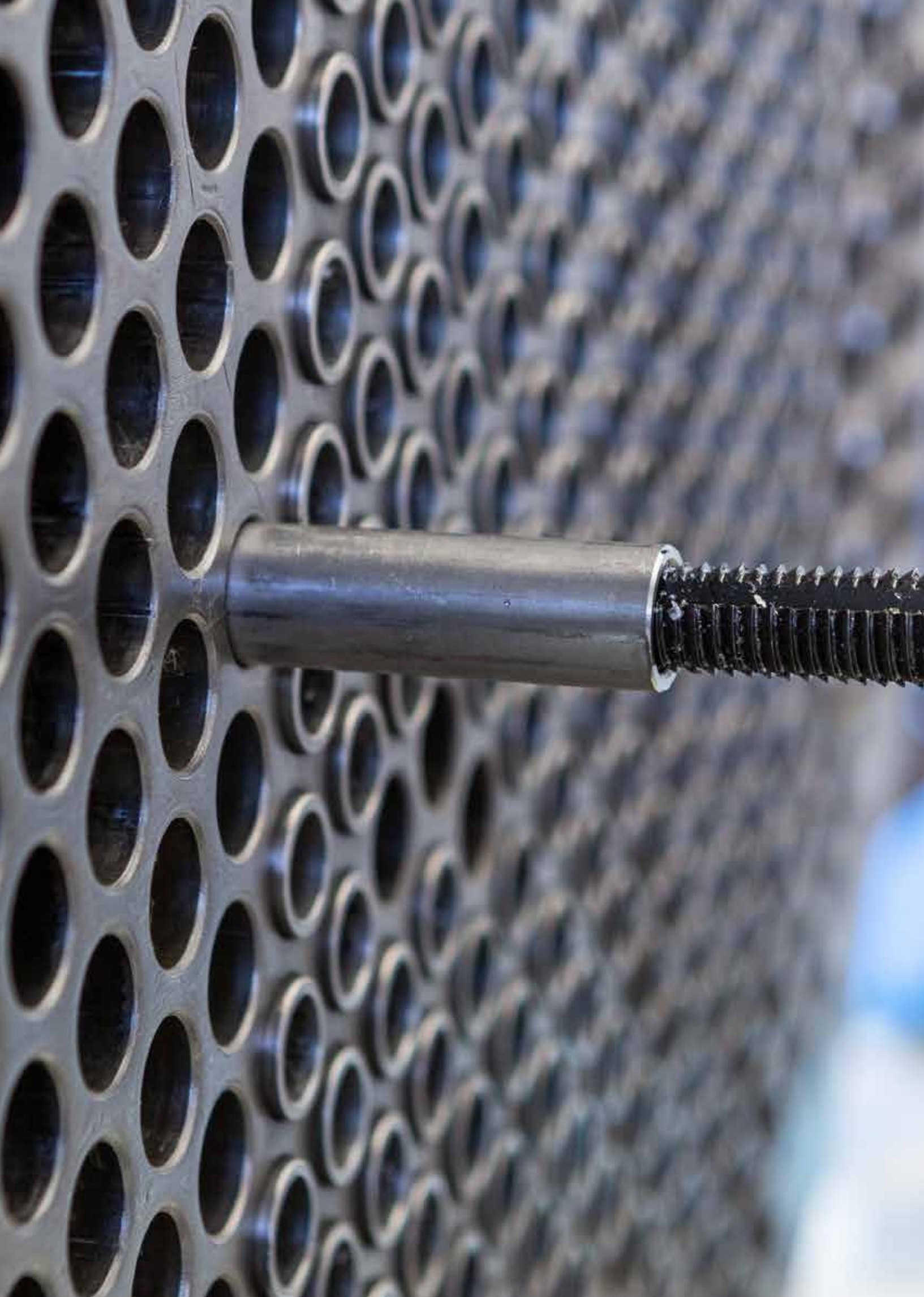







# *Onlypul*

*Semi-automated continuous hydraulic tube puller*

# Onlypul

*Semi-automated hydraulic tube puller for small-scale maintenance*

Maus Italia semi-automated hydraulic tube pullers are the result of more than forty years of experience in the field of tube extraction. Onlypul is designed and built for semi-automated and continuous tube extraction.

It comes in four versions depending on the extraction force ( Onlypul 15, Onlypul 30, Onlypul 45 and Onlypul 60 )



## **Semi-automatic**

Continuous tube extraction



## **Entry level**

For small-scale maintenance operations



## **Economico**

Full equipment at reduced cost

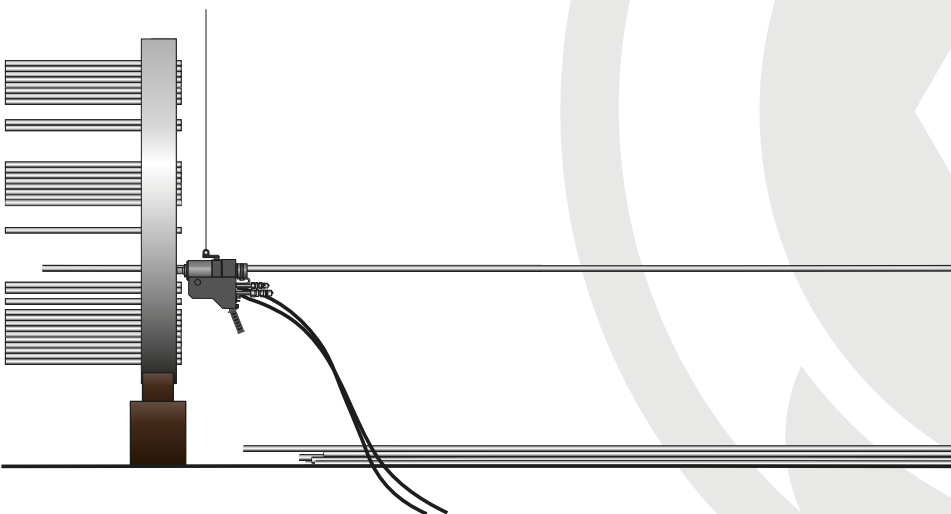

## The extraction process

La procedura di estrazione consiste nelle seguenti fasi:

- Select the correct tools ( TPC thrust collar, TPJ tightening jaw and TPM extraction mandrel ) according to the dimensions of the tube to be extracted
- Mount the TPC thrust collar and TPJ tightening jaw onto the ONLYPUL hydraulic puller
- Screw the TPM extraction mandrel into the tube inlet using the TPA pneumatic screwdriver and TPS reduction coupling (Pic. A)
- Position the ONLYPUL hydraulic puller onto the TPM extraction mandrel until the TPC collar is in contact with the tube plate (Pic. B)
- Proceed with the tube extraction. In the first extraction phase, the TPJ jaws will clamp the TPM mandrel ( Fig. C )
- In the following steps, the TPJ extraction jaws will clamp the tube until it is fully extracted ( Fig. D )





## Features that make the difference



### RC24

The RC24 remote control beside the knobs simplifies the working steps. In the electric version it is powered at a low voltage of 24 Volts.

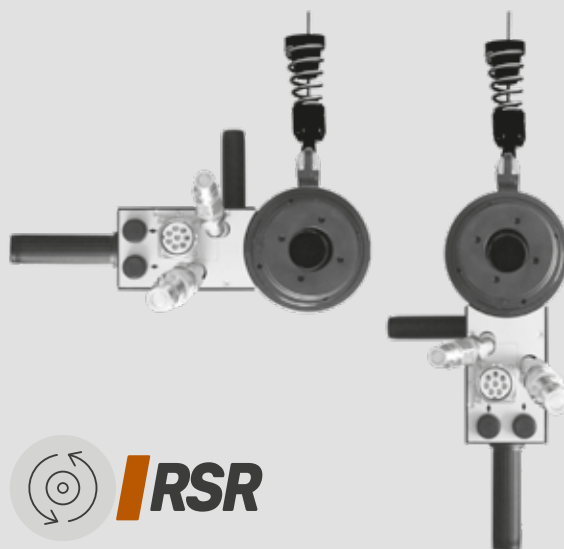

### RSR

The Revolving Support Ring on which ONLYPUL is suspended allows optimal positioning in the tightest spaces.



### HPHH

## High Pressure Hydraulic Hoses

High Pressure Hydraulic Hoses are 6 m (19.7 ft) long and certified for use up to 350 bar (5075 psi). They are equipped with FLAT fittings that reduce dripping during connection and disconnection from Onlypul and the TP10 hydraulic power unit. They are also equipped with safety systems that prevent a whip effect in the event of a broken hose-fitting connection.



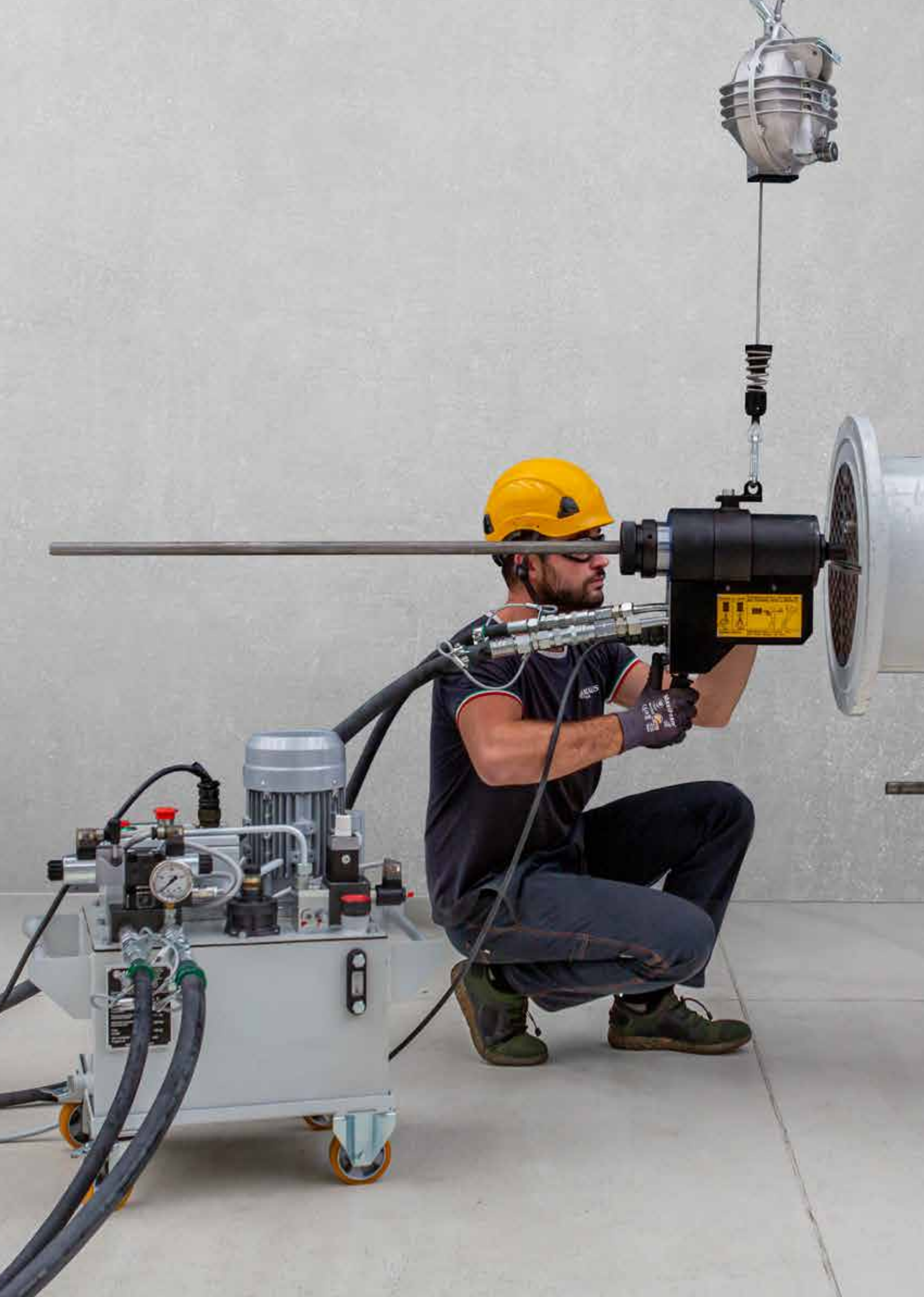

## Electric version

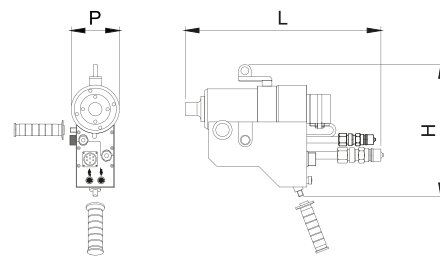

### Onlypul 15 EM

- > Tube (*min < de > max*) 9,5 ÷ 28,6 mm - 3/8" ÷ 1.1/8"
- > Maximum extraction force 15000 Kg / 33000 lb
- > Stroke 101,6 mm / 4"
- > Dimensions:
  - Width *L*: 500 mm / 19.7"
  - Depth *P*: 125 mm / 4.9"
  - Height *H*: 340 mm / 13.4"
- > Remote control supply 24 V
- > Weight 21 Kg / 46.2 lb

### Onlypul 30 EM

- > Tube (*min < de > max*) 9,5 ÷ 42,4 mm - 3/8" ÷ 1.1/4" GAS
- > Maximum extraction force 30000 Kg / 66000 lb
- > Stroke 101,6 mm / 4"
- > Dimensions:
  - Width *L*: 500 mm / 19.7"
  - Depth *P*: 155 mm / 6.1"
  - Height *H*: 430 mm / 16.9"
- > Remote control supply 24 V
- > Weight 38 Kg / 83.6 lb

### Onlypul 45 EM

- > Tube (*min < de > max*) 25,4 ÷ 76,2 mm - 1" ÷ 3"
- > Maximum extraction force 45000 Kg / 99000 lb
- > Stroke 50,8 mm / 2"
- > Dimensions:
  - Width *L*: 510 mm / 20.1"
  - Depth *P*: 190 mm / 7.5"
  - Height *H*: 430 mm / 16.9"
- > Remote control supply 24 V
- > Weight 55 Kg / 121.2 lb

### Onlypul 60 EM

- > Tube (*min < de > max*) 50,8 ÷ 101,6 mm - 2" ÷ 4"
- > Maximum extraction force 60000 Kg / 132000 lb
- > Stroke 50,8 mm / 2"
- > Dimensions:
  - Width *L*: 510 mm / 20.1"
  - Depth *P*: 220 mm / 8.7"
  - Height *H*: 450 mm / 17.7"
- > Remote control supply 24 V
- > Weight 71 Kg / 156.5 lb

## Power unit coupling

The electric version of the Onlypul tube puller is combined with the TP10EVV power unit, though it can also be used in combination with the TP30EPF power unit.



## **FRAV**

### Flow Rate Adjustment Valve

The Flow Rate Adjustment Valve is required to regulate the flow of hydraulic oil to ensure the best gripping of the jaw in the tube when using the TP10EVV power unit with Grippul 11E and Grippul 21E

## TP10EVV

### Semi-automated hydraulic electric power unit

- > Max pressure: 350 bar/5075 psi
- > Oil flow:
 

Lt/min ( bar )	US/gpm ( psi )
12 ( 0÷70 )	3.17 ( 0÷1015 psi )
0,9 ( 70÷350 )	0.24 ( 1015÷5075 psi )
- > Hydraulic oil ( not included ): 30Lt/8 US Gallon - Viscosità 46
- > Supply: 1,1 Kw-230/400V-50/60 Hz-3 phase
- > Remote power control supply: 24V
- > IP: 30
- > Dimensions:
 

Width: 680 mm / 26.8"
Depth: 500 mm / 19.7"
Height: 720 mm / 28.3"
- > Weight ( without hydraulic oil ): 86 Kg / 189 lb
- > Crate ( power unit + Onlypul transport case )

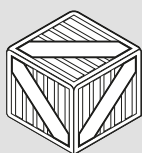

Width:	113 cm / 3.70 ft
Depth:	93 cm / 3.05 ft
Height:	96 cm / 3.15 ft
Weight:	211 Kg / 465 lb

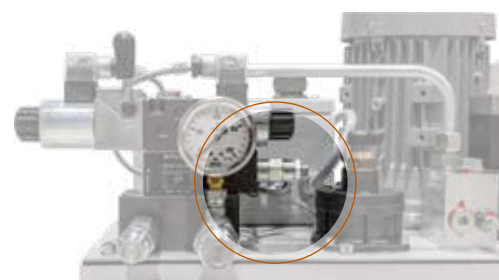

## **PAV**

### Pressure Adjustment Valve

The Pressure Adjustment Valve is required to adjust the maximum hydraulic oil pressure when using a TP10EVV power unit with KATTEX 6E and KATTEX 12E hydraulic tube cutters





## Pneumatic version

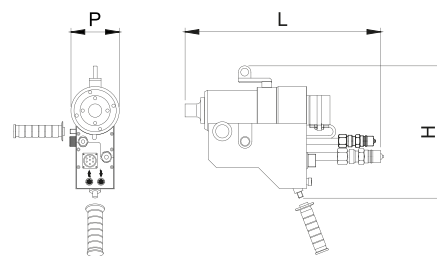

### Onlypul 15 PM

- > Tube (*min* < *de* > *max*) 9,2i5 ÷ 28,6 mm - 3/8" ÷ 1.1/8"
- > Maximum extraction force 15000 Kg / 33000 lb
- > Stroke 101,6 mm / 4"
- > Dimensions:
  - Width *L*: 500 mm / 19.7"
  - Depth *P*: 125 mm / 4.9"
  - Height *H*: 340 mm / 13.4"
- > Remote control supply 24 V
- > Weight 21 Kg / 46.2 lb

### Onlypul 30 PM

- > Tube (*min* < *de* > *max*) 9,5 ÷ 42,4 mm - 3/8" ÷ 1.1/4"
- > Maximum extraction force 30000 Kg / 66000 lb
- > Stroke 101,6 mm / 4"
- > Dimensions:
  - Width *L*: 500 mm / 19.7"
  - Depth *P*: 155 mm / 6.1"
  - Height *H*: 430 mm / 16.9"
- > Remote control supply 24 V
- > Weight 38 Kg / 83.6 lb

### Onlypul 45 PM

- > Tube (*min* < *de* > *max*) 25,4 ÷ 76,2 mm - 1" ÷ 3"
- > Maximum extraction force 45000 Kg / 99000 lb
- > Stroke 50,8 mm / 2"
- > Dimensions:
  - Width *L*: 510 mm / 20.1"
  - Depth *P*: 190 mm / 7.5"
  - Height *H*: 430 mm / 16.9"
- > Remote control supply 24 V
- > Weight 55 Kg / 121.2 lb

### Onlypul 60 PM

- > Tube (*min* < *de* > *max*) 50,8 ÷ 101,6 mm - 2" ÷ 4"
- > Maximum extraction force 60000 Kg / 132000 lb
- > Stroke 50,8 mm / 2"
- > Dimensions:
  - Width *L*: 510 mm / 20.1"
  - Depth *P*: 220 mm / 8.7"
  - Height *H*: 450 mm / 17.7"
- > Remote control supply 24 V
- > Weight 71 Kg / 156.5 lb

## Power unit coupling

The electric version of the Onlypul tube puller is combined with the TP10EVV power unit, though it can also be used in combination with the TP30EPF power unit.



## TP10PVV

### Semi-automatic hydraulic pneumatic power unit

- > Max pressure: 350 bar / 5075 psi
- > Oil flow:
 

Lt/min ( bar )	US/gpm ( psi )
12 ( 0÷70 )	3.17 ( 0÷1015 psi )
0,9 ( 70÷350 )	0,24 ( 1015÷5075 psi )
- > Hydraulic oil ( not included ): 30Lt/8 US Gallon - Viscosità 46
- > Motor power: 1,7 Kw - 7 bar ( 100 psi )
- > Air consumption: 1900 Lt/min ( 67 Cfm ) - 7 bar / 100 psi
- > Dimensions:
 

Width: 680 mm / 26.8"
Depth: 500 mm / 19.7"
Height: 600 mm / 23.6"
- > Weight ( without hydraulic oil ): 67,5 Kg / 149 lb
- > Crate ( power unit + Onlypul transport case )



Width:	113 cm / 3.70 ft
Depth:	93 cm / 3.05 ft
Height:	96 cm / 3.15 ft
Weight:	192 Kg / 423 lb



## FRAV

### Flow Rate Adjustment Valve

The Flow Rate Adjustment Valve is required to regulate the flow of hydraulic oil to ensure the best gripping of the jaw in the tube when using the **TP10PVV** power unit with **Grippul 11P** and **Grippul 21P**

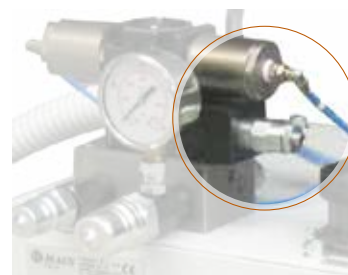

## PAV

### Pressure Adjustment Valve

The Pressure Adjustment Valve is required to adjust the maximum hydraulic oil pressure when using a **TP10PVV** power unit with **KATTEX 6P** and **KATTEX 12P** hydraulic tube cutters



# TPM

Extraction mandrel for tubes from 3/8" ( 9,5mm ) to 2.1/2" ( 63,5mm )

Tube features				Mandrel <input checked="" type="checkbox"/>	
$d_e$		$sp$	$d_j$		
inches	mm	B.W.G	mm	inches	Cod. In.
<b>3/8" (9,5)</b>	17 ÷ 19	6,5 ÷ 7,5	0.256 ÷ 0.295	<b>TPM-7</b>	5/16"
	20 ÷ 24	7,5 ÷ 8,5	0.295 ÷ 0.335	<b>TPM-8</b>	
<b>1/2" (12,7)</b>	14 ÷ 16	8,5 ÷ 9,5	0.335 ÷ 0.374	<b>TPM-9</b>	3/8"
	17 ÷ 18	9,5 ÷ 10,5	0.374 ÷ 0.413	<b>TPM-10</b>	
	19 ÷ 21	10,5 ÷ 11,5	0.413 ÷ 0.453	<b>TPM-11</b>	
	24	11,5 ÷ 12,5	0.453 ÷ 0.492	<b>TPM-12</b>	
<b>5/8" (15,9)</b>	12 ÷ 13	10,3 ÷ 11,1	0.407 ÷ 0.435	<b>TPM-11A</b>	1/2"
	14 ÷ 15	11,7 ÷ 12,2	0.459 ÷ 0.481	<b>TPM-12A</b>	
	16 ÷ 17	12,5 ÷ 13,5	0.492 ÷ 0.531	<b>TPM-13A</b>	
	19 ÷ 21	13,5 ÷ 14,5	0.531 ÷ 0.571	<b>TPM-14A</b>	
	23 ÷ 24	14,5 ÷ 15,5	0.571 ÷ 0.610	<b>TPM-15A</b>	
<b>3/4" (19,0)</b>	11	12,5 ÷ 13,5	0.492 ÷ 0.531	<b>TPM-13</b>	5/8"
	12 ÷ 13	13,5 ÷ 14,5	0.531 ÷ 0.571	<b>TPM-14</b>	
	14 ÷ 15	14,5 ÷ 15,5	0.571 ÷ 0.610	<b>TPM-15</b>	
	16 ÷ 17	15,5 ÷ 16,5	0.610 ÷ 0.650	<b>TPM-16</b>	
	18 ÷ 20	16,5 ÷ 17,5	0.650 ÷ 0.689	<b>TPM-17</b>	
	21 ÷ 24	17,5 ÷ 18,5	0.689 ÷ 0.728	<b>TPM-18</b>	
<b>7/8" (22,2)</b>	14	17,5 ÷ 18,5	0.689 ÷ 0.728	<b>TPM-18S</b>	5/8"
	16 ÷ 17	18,5 ÷ 19,5	0.728 ÷ 0.768	<b>TPM-19S</b>	
	18 ÷ 19	19,5 ÷ 20,5	0.768 ÷ 0.807	<b>TPM-20S</b>	
	21 ÷ 24	20,5 ÷ 21,5	0.807 ÷ 0.846	<b>TPM-21</b>	
<b>1" (25,4)</b>	10 ÷ 11	18,5 ÷ 19,5	0.728 ÷ 0.768	<b>TPM-19</b>	3/4"
	12	19,5 ÷ 20,5	0.768 ÷ 0.807	<b>TPM-20</b>	
	13 ÷ 14	20,5 ÷ 21,5	0.807 ÷ 0.846	<b>TPM-21</b>	
	15 ÷ 16	21,5 ÷ 22,5	0.846 ÷ 0.886	<b>TPM-22</b>	
	18	22,5 ÷ 23,5	0.886 ÷ 0.925	<b>TPM-23</b>	
	19 ÷ 20	23,5 ÷ 24,5	0.925 ÷ 0.965	<b>TPM-24</b>	
	21 ÷ 24	24,5 ÷ 25,4	0.956 ÷ 1.004	<b>TPM-25G</b>	
<b>3/4" Gas(26,9)</b>	13	21,5 ÷ 22,5	0.846 ÷ 0.886	<b>TPM-22G</b>	3/4"
	14 ÷ 15	22,5 ÷ 23,5	0.886 ÷ 0.925	<b>TPM-23G</b>	
	16 ÷ 17	23,5 ÷ 24,5	0.925 ÷ 0.965	<b>TPM-24G</b>	
	19 ÷ 21	24,5 ÷ 25,4	0.956 ÷ 1.004	<b>TPM-25</b>	
<b>1.1/4" (31,8)</b>	10	24,5 ÷ 25,4	0.956 ÷ 1.004	<b>TPM-25</b>	1"
	11 ÷ 12	25,5 ÷ 26,5	1.004 ÷ 1.043	<b>TPM-26</b>	
	13	26,5 ÷ 27,5	1.043 ÷ 1.083	<b>TPM-27</b>	
	14 ÷ 15	27,5 ÷ 28,5	1.083 ÷ 1.112	<b>TPM-28</b>	
	16 ÷ 18	28,5 ÷ 29,5	1.112 ÷ 1.161	<b>TPM-29</b>	
	19 ÷ 22	29,5 ÷ 30,5	1.161 ÷ 1.201	<b>TPM-30</b>	
	23 ÷ 24	30,5 ÷ 31,5	1.201 ÷ 1.240	<b>TPM-31</b>	
<b>1" Gas (33,7)</b>	9	25,5 ÷ 26,5	1.004 ÷ 1.043	<b>TPM-26G</b>	1"
	10	26,5 ÷ 27,5	1.043 ÷ 1.063	<b>TPM-27G</b>	
	11	27,5 ÷ 28,5	1.083 ÷ 1.122	<b>TPM-28G</b>	
	13 ÷ 14	28,5 ÷ 29,5	1.122 ÷ 1.161	<b>TPM-29G</b>	

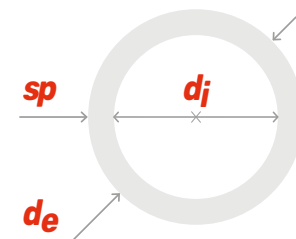

Dimensions fit for  
**Onlypul 15**

Dimensions fit for  
**Onlypul 30**

Dimensions fit for  
**Onlypul 45**



**Tube features** **Mandrel**

$d_e$		$sp$	$d_i$		Cod.	In.
inches	mm	B.W.G	mm	inches		

<b>1.1/2" (38,1)</b>	10 ÷ 11	31,5 ÷ 32,5	1.240 ÷ 1.280	<b>TPM-32</b>	1"
	12 ÷ 13	32,5 ÷ 33,5	1.280 ÷ 1.319	<b>TPM-33</b>	
	14	33,5 ÷ 34,5	1.319 ÷ 1.358	<b>TPM-34</b>	
	15 ÷ 17	34,5 ÷ 35,5	1.358 ÷ 1.398	<b>TPM-35</b>	
	18 ÷ 20	35,5 ÷ 36,5	1.398 ÷ 1.437	<b>TPM-36</b>	
<b>1.1/4" Gas (42,4)</b>	21 ÷ 24	36,5 ÷ 37,5	1.437 ÷ 1.280	<b>TPM-37</b>	1"
	12	36,5 ÷ 37,5	1.437 ÷ 1.476	<b>TPM-37G</b>	
	15 ÷ 16	37,5 ÷ 38,5	1.476 ÷ 1.516	<b>TPM-38G</b>	
	14 ÷ 16	38,5 ÷ 39,5	1.516 ÷ 1.555	<b>TPM-39G</b>	
	17 ÷ 19	39,5 ÷ 40,5	1.555 ÷ 1.594	<b>TPM-40G</b>	
<b>1.3/4" (44,4)</b>	20 ÷ 24	40,5 ÷ 41,5	1.594 ÷ 1.634	<b>TPM-41G</b>	1"
	10 ÷ 11	37,5 ÷ 38,5	1.476 ÷ 1.516	<b>TPM-38/44</b>	
	12	38,5 ÷ 39,5	1.516 ÷ 1.555	<b>TPM-39/44</b>	
	13 ÷ 14	39,5 ÷ 40,5	1.555 ÷ 1.594	<b>TPM-40/44</b>	
	15 ÷ 16	40,5 ÷ 41,5	1.594 ÷ 1.634	<b>TPM-41/44</b>	
<b>1.1/2" Gas (48,3)</b>	18 ÷ 19	41,5 ÷ 42,5	1.634 ÷ 1.673	<b>TPM-42/44</b>	1"
	20 ÷ 24	42,5 ÷ 43,5	1.673 ÷ 1.713	<b>TPM-43/44</b>	
	11 ÷ 12	42,5 ÷ 43,5	1.673 ÷ 1.713	<b>TPM-43G</b>	
	13 ÷ 14	43,5 ÷ 44,5	1.713 ÷ 1.752	<b>TPM-44G</b>	
	15 ÷ 17	44,5 ÷ 45,5	1.752 ÷ 1.791	<b>TPM-45G</b>	
<b>2" (50,8)</b>	18 ÷ 19	45,5 ÷ 43,5	1.791 ÷ 1.831	<b>TPM-46G</b>	1"
	10	43,5 ÷ 44,5	1.713 ÷ 1.752	<b>TPM-44/51</b>	
	11 ÷ 12	44,5 ÷ 45,5	1.752 ÷ 1.791	<b>TPM-45/51</b>	
	13	45,5 ÷ 46,5	1.791 ÷ 1.831	<b>TPM-46/51</b>	
	14 ÷ 15	46,5 ÷ 47,5	1.831 ÷ 1.870	<b>TPM-47/51</b>	
<b>2.1/4" (57,1)</b>	16 ÷ 18	47,5 ÷ 48,5	1.870 ÷ 1.909	<b>TPM-48/51</b>	1"
	19 ÷ 22	48,5 ÷ 21,5	1.909 ÷ 1.949	<b>TPM-49/51</b>	
	9 ÷ 10	49,5 ÷ 50,5	1.949 ÷ 1.985	<b>TPM-50/57</b>	
<b>2" Gas (60,3)</b>	11	50,5 ÷ 51,5	1.985 ÷ 1.476	<b>TPM-51/57</b>	1.1/2"
	12 ÷ 13	51,5 ÷ 52,5	2.028 ÷ 2.067	<b>TPM-52/57</b>	
	7	50,5 ÷ 51,5	1.999 ÷ 2.029	<b>TPM-51G</b>	
<b>2.1/2" (63,5)</b>	8	51,5 ÷ 52,5	2.028 ÷ 2.057	<b>TPM-52G</b>	1.1/2"
	9	52,5 ÷ 53,5	2.067 ÷ 2.105	<b>TPM-53G</b>	
	7	53,5 ÷ 54,4	2.105 ÷ 2.145	<b>TPM-54/63</b>	
	8	54,5 ÷ 55,4	2.145 ÷ 2.185	<b>TPM-55/63</b>	
	9	55,5 ÷ 56,5	2.185 ÷ 2.224	<b>TPM-56/63</b>	1.1/2"
	10	56,5 ÷ 57,5	2.224 ÷ 2.264	<b>TPM-57/63</b>	

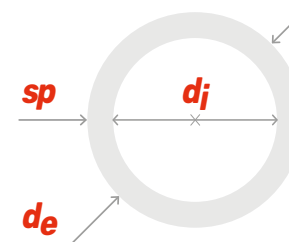

Dimensions fit for  
**Onlypul 30**

Dimensions fit for  
**Onlypul 45**

Dimensions fit for  
**Onlypul 60**



## Jaw TPJ



<i>de</i>	<i>Onlypul 15</i>	<i>Onlypul 30</i>	<i>Onlypul 45</i>	<i>Onlypul 60</i>
<i>inches</i>	<i>Cod.</i>	<i>Cod.</i>	<i>Cod.</i>	<i>Cod.</i>
3/8"	TPJ/15-1	TPJ/30-1	-	-
1/2"	TPJ/15-2	TPJ/30-2	-	-
5/8"	TPJ/15-3	TPJ/30-3	-	-
3/4"	TPJ/15-4	TPJ/30-4	-	-
7/8"	TPJ/15-4/A	TPJ/30-4/A	-	-
1"	TPJ/15-5	TPJ/30-5	TPJ/45-5	-
3/4" Gas	-	TPJ/30-6	TPJ/45-6	-
1.1/4"	-	TPJ/30-7	TPJ/45-7	-
1" Gas	-	TPJ/30-8	TPJ/45-8	-
1.1/2"	-	TPJ/30-9	TPJ/45-9	-
1.1/4" Gas	-	TPJ/30-10	TPJ/45-10	-
1.3/4"	-	-	TPJ/45-11	-
1.1/2" Gas	-	-	TPJ/45-12	-
2"	-	-	TPJ/45-13	TPJ/60-13
2.1/4"	-	-	TPJ/45-14	TPJ/60-14
2" Gas	-	-	TPJ/45-15	TPJ/60-15
2.1/2"	-	-	TPJ/45-16	TPJ/60-16
3"	-	-	TPJ/45-17	TPJ/60-17
3.1/2"	-	-	-	TPJ/60-18
4"	-	-	-	TPJ/60-19

## TPC Collars



<i>de</i>	<i>Onlypul 15</i>	<i>Onlypul 30</i>	<i>Onlypul 45</i>	<i>Onlypul 60</i>
<i>inches</i>	<i>Cod.</i>	<i>Cod.</i>	<i>Cod.</i>	<i>Cod.</i>
3/8"	TPC-11	TPC-11	-	-
1/2"	TPC-14	TPC-14	-	-
5/8"	TPC-18	TPC-18	-	-
3/4"	TPC-21	TPC-21	-	-
7/8"	TPC-25	TPC-25	-	-
1"	TPC-28	TPC-28	TPC-28	-
3/4" Gas	-	TPC-31	TPC-31	-
1.1/4"	-	TPC-34	TPC-34	-
1" Gas	-	TPC-37	TPC-37	-
1.1/2"	-	TPC-41	TPC-41	-
1.1/4" Gas	-	TPC-44	TPC-44	-
1.3/4"	-	-	TPC/45-48	-
1.1/2" Gas	-	-	TPC/45-53	-
2"	-	-	TPC/45-56	TPC/60-56
2.1/4"	-	-	TPC/45-60	TPC/60-60
2" Gas	-	-	TPC/45-63	TPC/60-63
2.1/2"	-	-	TPC/45-66	TPC/60-66
3"	-	-	TPC/45-80	TPC/60-80
3.1/2"	-	-	-	TPC/60-93
4"	-	-	-	TPC/60-105

# TPM-K



Quick gripping extraction mandrel for tubes from 38,1 mm ( 1.1/2" ) to 101,6 mm ( 4" ).

An exclusive Maus Italia-designed extraction spear: used in combination with the Runpul puller allows for a rapid tube extraction without the need for tightening with a screwer ( no screwer or specific keys required ).

Tube				Mandrel	Cone	Jaw	Extension		
<i>d<sub>e</sub></i>	<i>sp</i>	<i>d<sub>i</sub></i>							
inches mm	B.W.G	mm	inches	Cod.	Inches / mm	Cod.	Cod.	Cod.	Cod.
<b>1.1/2"</b> <b>(38,1)</b>	10 ÷ 11	31,5 ÷ 32,5	1.240 ÷ 1.280	TPM-K-32	CK-32÷37	JK-32	RK-32÷37	1.1/4"	
	12 ÷ 13	32,5 ÷ 33,5	1.280 ÷ 1.319	TPM-K-33		JK-33			
	14	33,5 ÷ 34,5	1.319 ÷ 1.358	TPM-K-34		JK-34			
	15 ÷ 17	34,5 ÷ 35,5	1.358 ÷ 1.397	TPM-K-35		JK-35			
	18 ÷ 20	35,5 ÷ 36,5	1.397 ÷ 1.437	TPM-K-36		JK-36			
	21 ÷ 24	36,5 ÷ 37,5	1.437 ÷ 1.476	TPM-K-37		JK-37			
<b>1.3/4"</b> <b>(44,4)</b>	10 ÷ 11	37,5 ÷ 38,5	1.476 ÷ 1.516	TPM-K-38	CK-38÷43	JK-38	RK-38÷43	1.1/4"	
	12	38,5 ÷ 39,5	1.516 ÷ 1.555	TPM-K-39		JK-39			
	13 ÷ 14	39,5 ÷ 40,5	1.555 ÷ 1.594	TPM-K-40		JK-40			
	15 ÷ 16	40,5 ÷ 41,5	1.594 ÷ 1.673	TPM-K-41		JK-41			
	18 ÷ 19	41,5 ÷ 42,5	1.634 ÷ 1.673	TPM-K-42		JK-42			
	20 ÷ 24	42,5 ÷ 43,5	1.673 ÷ 1.713	TPM-K-43		JK-43			
<b>2"</b> <b>(50,8)</b>	10	43,5 ÷ 44,5	1.713 ÷ 1.752	TPM-K-44	CK-44÷49	JK-44	RK-44÷49	1.1/4"	
	11 ÷ 12	44,5 ÷ 45,5	1.752 ÷ 1.791	TPM-K-45		JK-45			
	13	45,5 ÷ 46,5	1.791 ÷ 1.831	TPM-K-46		JK-46			
	14 ÷ 15	46,5 ÷ 47,5	1.831 ÷ 1.870	TPM-K-47		JK-47			
	16 ÷ 18	47,5 ÷ 48,5	1.870 ÷ 1.909	TPM-K-48		JK-48			
	19 ÷ 22	48,5 ÷ 49,5	1.909 ÷ 1.949	TPM-K-49		JK-49			
<b>2.1/4"</b> <b>(57,1)</b>	9 ÷ 10	49,5 ÷ 50,5	1.949 ÷ 1.988	TPM-K-50	CK-50÷52	JK-50	RK-50÷52	1.1/2"	
	11	50,5 ÷ 51,5	1.988 ÷ 2.028	TPM-K-51		JK-51			
	12 ÷ 13	51,5 ÷ 52,5	2.028 ÷ 2.067	TPM-K-52		JK-52			
<b>2.1/2"</b> <b>(63,5)</b>	7	53,5 ÷ 54,5	2.106 ÷ 2.146	TPM-K-54	CK-54÷57	JK-54	RK-54÷57	1.1/2"	
	8	54,5 ÷ 55,5	2.146 ÷ 2.185	TPM-K-55		JK-55			
	9	55,5 ÷ 56,5	2.185 ÷ 2.224	TPM-K-56		JK-56			
	10	56,5 ÷ 57,5	2.224 ÷ 2.264	TPM-K-57		JK-57			
<b>3"</b> <b>(76,2)</b>	7	66,5 ÷ 67,5	2.618 ÷ 2.667	TPM-K-67	CK-67÷70	JK-67	RK-67÷70	1.3/4"	
	8	67,5 ÷ 68,5	2.657 ÷ 2.697	TPM-K-68		JK-68			
	9 ÷ 10	68,5 ÷ 69,5	2.697 ÷ 2.736	TPM-K-69		JK-69			
	11	69,5 ÷ 70,5	2.736 ÷ 2.776	TPM-K-70		JK-70			
<b>3.1/2"</b> <b>(88,9)</b>	6	78,5 ÷ 79,5	3.091 ÷ 3.130	TPM-K-79	CK-79÷82	JK-79	RK-79÷82	1.3/4"	
	7	79,5 ÷ 80,5	3.130 ÷ 3.169	TPM-K-80		JK-80			
	8 ÷ 9	80,5 ÷ 81,5	3.169 ÷ 3.209	TPM-K-81		JK-81			
	10	81,5 ÷ 82,5	3.209 ÷ 3.248	TPM-K-82		JK-82			
<b>4"</b> <b>(101,6)</b>	6	91,5 ÷ 92,5	3.602 ÷ 3.642	TPM-K-92	CK-92÷95	JK-92	RK-92÷95	1.3/4"	
	7 ÷ 8	92,5 ÷ 93,5	3.642 ÷ 3.681	TPM-K-93		JK-93			
	9	93,5 ÷ 94,5	3.681 ÷ 3.720	TPM-K-94		JK-94			
	10	94,5 ÷ 95,5	3.720 ÷ 3.760	TPM-K-95		JK-95			

# T2PM

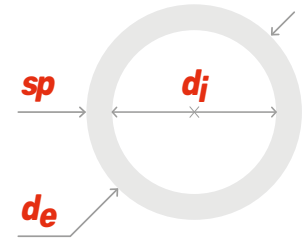

Tube features				Mandrel	Extension	Jaw	Cone	
$d_e$		$sp$	$d_{im}$					
inches	mm	B.W.G	mm	inches	Cod.	Inches mm	Cod.	Cod.
<b>1/2"</b> (12,7)	14 ÷ 16	8,5 ÷ 9,5	0.335 ÷ 0.374	T2PM-S9	17 0.669	T2PM-R9÷12	TPJ/15-4 TPJ/30-4	TPC/21
	17 ÷ 18	9,5 ÷ 10,5	0.374 ÷ 0.413	T2PM-S10				
	19 ÷ 21	10,5 ÷ 11,5	0.413 ÷ 0.453	T2PM-S11				
	24	11,5 ÷ 12,5	0.453 ÷ 0.492	T2PM-S12				
<b>5/8"</b> (15,9)	16 ÷ 17	12,5 ÷ 13,5	0.492 ÷ 0.531	T2PM-S13	22 0.866	T2PM-R13÷24	TPJ/15-5 TPJ/30-5	TPC/28
	19 ÷ 21	13,5 ÷ 14,5	0.531 ÷ 0.571	T2PM-S14				
	23 ÷ 24	14,5 ÷ 13,5	0.571 ÷ 0.610	T2PM-S15				
<b>3/4"</b> (19,0)	11	12,5 ÷ 14,5	0.492 ÷ 0.531	T2PM-S13	22 0.866	T2PM-R13÷24	TPJ/15-5 TPJ/30-5	TPC/28
	12 ÷ 13	13,5 ÷ 15,5	0.531 ÷ 0.571	T2PM-S14				
	14 ÷ 15	14,5 ÷ 13,5	0.571 ÷ 0.610	T2PM-S15				
	16 ÷ 17	15,5 ÷ 14,5	0.610 ÷ 0.650	T2PM-S16				
	18 ÷ 20	16,5 ÷ 15,5	0.650 ÷ 0.689	T2PM-S17				
	21 ÷ 24	17,5 ÷ 18,5	0.689 ÷ 0.728	T2PM-S18				
<b>7/8"</b> (22,2)	14	17,5 ÷ 18,5	0.689 ÷ 0.728	T2PM-S18	22 0.866	T2PM-R13÷24	TPJ/15-5 TPJ/30-5	TPC/28
	16 ÷ 17	18,5 ÷ 19,5	0.728 ÷ 0.768	T2PM-S19				
	18 ÷ 19	19,5 ÷ 20,5	0.768 ÷ 0.807	T2PM-S20				
<b>1"</b> (25,4)	10 ÷ 11	18,5 ÷ 19,5	0.728 ÷ 0.768	T2PM-S19	22 0.866	T2PM-R13÷24	TPJ/15-5 TPJ/30-5	TPC/28
	12	19,5 ÷ 20,5	0.768 ÷ 0.807	T2PM-S20				
	13 ÷ 14	20,5 ÷ 21,5	0.807 ÷ 0.846	T2PM-S21				
	15 ÷ 16	21,5 ÷ 22,5	0.846 ÷ 0.886	T2PM-S22				
	18	22,5 ÷ 23,5	0.886 ÷ 0.925	T2PM-S23				
	19 ÷ 20	23,5 ÷ 24,5	0.925 ÷ 0.965	T2PM-S24				

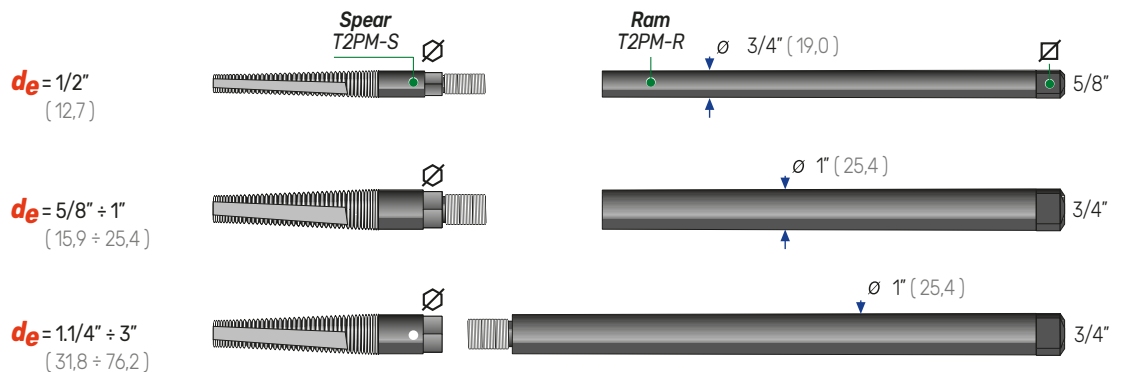

Tube features				Mandrel	Extension	Jaw	Cone		
$d_e$		$sp$	$dim$						
inches	mm	B.W.G	mm	inches	Cod.	Inches mm	Cod.	Cod.	Cod.
<b>1.1/4"</b> <b>(31,8)</b>	10	24,5 ÷ 25,5	0.956 ÷ 1.004	<b>T2PM-S25</b>	30 1.181	T2PM-R25÷48	TPJ/30-5	TPC/34/200	
	11 ÷ 12	25,5 ÷ 26,5	1.004 ÷ 1.043	<b>T2PM-S26</b>					
	13	25,5 ÷ 26,5	1.043 ÷ 1.083	<b>T2PM-S27</b>					
	14 ÷ 15	27,5 ÷ 28,5	1.083 ÷ 1.112	<b>T2PM-S28</b>					
	16 ÷ 18	28,5 ÷ 29,5	1.112 ÷ 1.161	<b>T2PM-S29</b>					
	19 ÷ 22	29,5 ÷ 30,5	1.161 ÷ 1.201	<b>T2PM-S30</b>					
	23 ÷ 24	30,5 ÷ 31,5	1.201 ÷ 1.240	<b>T2PM-S31</b>					
<b>1.1/2"</b> <b>(38,1)</b>	10 ÷ 11	31,5 ÷ 32,5	1.240 ÷ 1.280	<b>T2PM-S32</b>	30 1.181	T2PM-R25÷48	TPJ/30-5	TPC/45/200	
	12 ÷ 13	32,5 ÷ 33,5	1.280 ÷ 1.319	<b>T2PM-S33</b>					
	14	33,5 ÷ 34,5	1.319 ÷ 1.358	<b>T2PM-S34</b>					
	15 ÷ 17	34,5 ÷ 35,5	1.358 ÷ 1.398	<b>T2PM-S35</b>					
	18 ÷ 20	35,5 ÷ 36,5	1.398 ÷ 1.437	<b>T2PM-S36</b>					
	21 ÷ 24	36,5 ÷ 37,5	1.437 ÷ 1.476	<b>T2PM-S37</b>					
<b>1.3/4"</b> <b>(44,4)</b>	10 ÷ 11	37,5 ÷ 38,5	1.476 ÷ 1.516	<b>T2PM-S38</b>	30 1.181	T2PM-R25÷48	TPJ/30-5	TPC/45/200	
	12	38,5 ÷ 39,5	1.516 ÷ 1.555	<b>T2PM-S39</b>					
	13 ÷ 14	39,5 ÷ 40,5	1.555 ÷ 1.594	<b>T2PM-S40</b>					
	15 ÷ 16	40,5 ÷ 41,5	1.594 ÷ 1.634	<b>T2PM-S41</b>					
<b>2"</b> <b>(50,8)</b>	10	43,5 ÷ 44,5	1.713 ÷ 1.752	<b>T2PM-S44</b>	30 1.181	T2PM-R25÷48	TPJ/30-5	TPC/56/200	
	11 ÷ 12	44,5 ÷ 45,5	1.752 ÷ 1.791	<b>T2PM-S45</b>					
	14 ÷ 15	46,5 ÷ 47,5	1.831 ÷ 1.870	<b>T2PM-S47</b>					
	16 ÷ 18	47,5 ÷ 48,5	1.870 ÷ 1.909	<b>T2PM-S48</b>					
<b>2.1/2" (63,5)</b>	9	55,5 ÷ 56,5	2.185 ÷ 2.224	<b>T2PM-S56</b>	30 1.181	T2PM-R25÷48	TPJ/30-5	TPC/80/200	
<b>3" (76,2)</b>	9 ÷ 10	68,5 ÷ 69,5	2.697 ÷ 2.736	<b>T2PM-S59</b>					





## Equipment

- > Transport case
- > Onlypul hydraulic puller
- > N°2 hydraulic hoses ( length: 6m )
- > Set of spares gaskets
- > Set of series keys
- > Instruction manual



Transport case



Onlypul tube puller



N°2 hydraulic hoses



Set of spare gaskets



Set of service keys

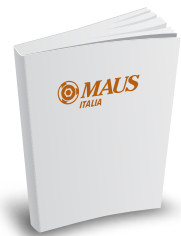

Instruction manual

All the accessories offered by Maus Italia to support the Onlypul series tube extraction equipment.

## Accessories

### TPA

#### Pneumatic impact wrench

Pneumatic impact wrench for quick and safe insertion of the TPM spear before each extraction. The TPA screwdriver is supplied in a practical and handy carrying case complete with connecting tubes and service keys.



Model	TPM	Working pressure		Air connect	A	Weight	
		bar	Psi			Kg	Lb
TPA 1	TPM 7 ÷ TPM 15 A	6,3	91.4	3/8" Gas	3/4"	5	10.8
TPA 2	TPM 13 ÷ TPM 20 S	6,3	91.4	1/2" Gas	1"	6,3	13.8
TPA 3A	TPM 19 ÷ TPM 37	6,3	91.4	1/2" Gas	1"	9,3	20.6
TPA 4	TPM 37 G ÷ TPM 49/51	6,3	91.4	1/2" Gas	1"	15,0	32.9
TPA 5	TPM 50/57 ÷ TPM 57/63	6,3	91.4	3/4" Gas	1.1/2"	32,0	70.55

### TPS

#### Adapter

Adapter between the TPA impact wrench and the TPM spear to be mounted, available in different sizes as required.



### TPB

#### Balancer

Model	Balancer	Range
Onlypul 15	TPB15	25-30 Kg / 55-66 lb
Onlypul 30	TPB30	45-55 Kg / 99-121 lb
Onlypul 45	TPB45	55-65 Kg / 121-143 lb
Onlypul 60	TPB60	100-120 Kg / 220-265 lb



Model	TPA	TPM
	A	B
TPS 1B	3/4"	5/16"
TPS 2B	3/4"	3/8"
TPS 3B	3/4"	1/2"
TPS 3A	1"	1/2"
TPS 4	1"	5/8"
TPS 5	1"	3/4"
TPS 6	1"	1"
TPS 6A	1"	1.1/2"
TPS 7	1.1/2"	1"
TPS 8	1.1/2"	1.1/2"



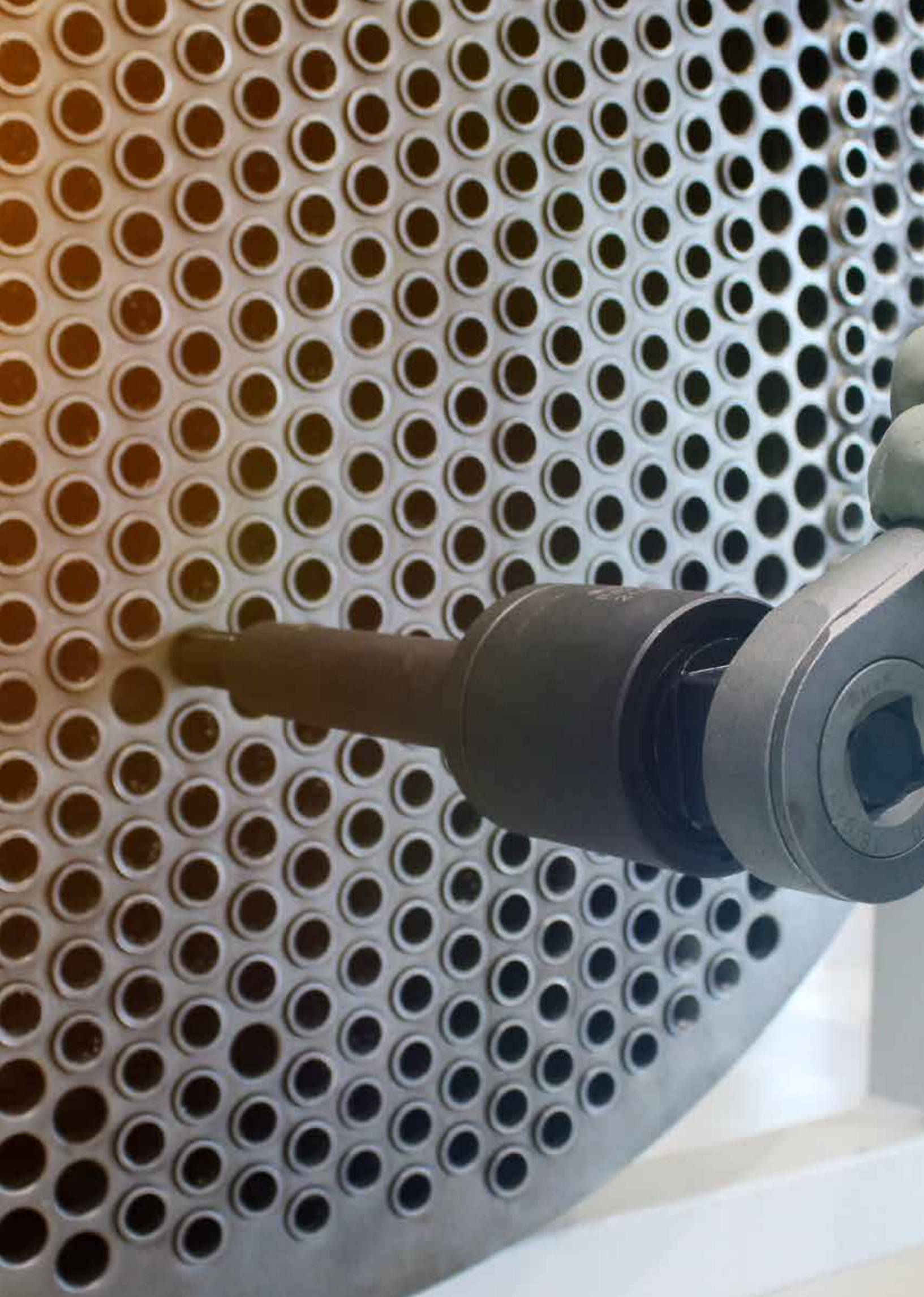

# *Manual tools*

*Equipment for the manual maintenance of the tubes in the heat exchangers*



# Manual tools

## *Equipment for the manual maintenance of the tubes in the heat exchangers*

This panorama of manual tools is the entire products of Maus Italia for the manual, low cost maintenance of tubes in heat exchangers in oil refineries, condensers in electric power stations, boilers, etc...

These Manual tools work in synergy to increase the effectiveness of the work on the tube being replaced. The tube reamer F/791 starts first by reducing the thickness of the tube to enable the F/793 to enter the part that has been reamed ( therefore offering less resistance ) and to expel the tube. The tube collapsing tool F/792 is used when the thickness of the tube is not high and offer less resistance.

Manual tools also includes manual tube cutters F/790, a manual extractors F/800 and a pneumatic hammer F/789 suggested for use with the above tools.

**Flexibility and economy of use**

**High quality of maintenance**

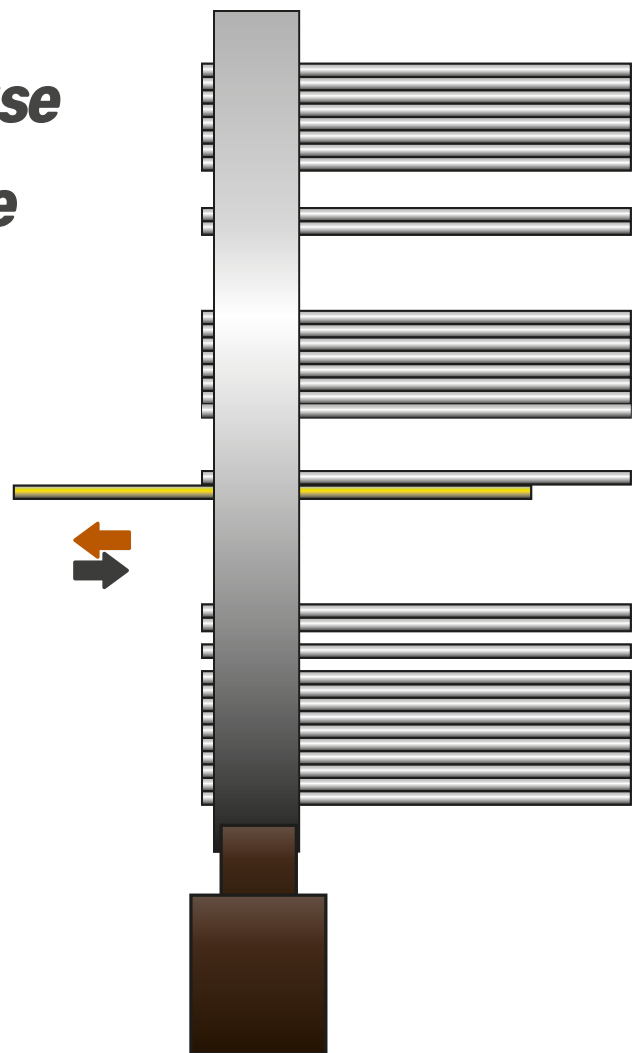

# F/790

One revolution tube cutter



Cheaper tube cutter, adjustable reach from 50,8 mm (2") to 152,4 mm (6").

The F/790 was designed for hand use with a tap wrench and its functioning is based on the eccentricity of the blade.

Work on the first tubesheet with the one-revolution tube cutter F/790 to cut the tube to be replaced. After cutting the tube stub is connected to the first tubesheet and the remaining part of the tube is connected to the second tubesheet.

"	$d_e$		$sp$		$d_j$		F/790 Cod.	Spare bit Cod.	∩ inches
	mm	B.W.G	mm	inches	mm	inches			
1/2"	(12,7)	18	1.2	0.049	10,2	0.402	F/790-1	BIT-F790-1-2	1/4"
		20	0,9	0.035	10,9	0.430	F/790-2		
5/8"	(15,9)	14	2,1	0.083	11,7	0.459	F/790-3	BIT-F790-3 BIT-F790-4 BIT-F790-5 BIT-F790-6	3/8"
		16	1,6	0.065	12,6	0.495	F/790-4		
		18	1,2	0.049	13,4	0.527	F/790-5		
		20	0,9	0.035	14,1	0.555	F/790-6		
3/4"	(19,0)	14	2,1	0.083	14,8	0.584	F/790-7	BIT-F790-7 BIT-F790-8÷16	3/8"
		16	1,6	0.065	15,7	0.620	F/790-8		
		18	1,2	0.049	16,6	0.652	F/790-9		
		20	0,9	0.035	17,3	0.680	F/790-10		
		22	0,7	0.028	17,6	0.694	F/790-11		
7/8"	(22,2)	14	2,1	0.083	18,0	0.709	F/790-12	BIT-F790-8÷16	1/2"
		16	1,6	0.065	18,9	0.745	F/790-13		
		18	1,2	0.049	19,7	0.777	F/790-14		
		20	0,9	0.035	20,4	0.805	F/790-15		
		22	0,7	0.028	20,8	0.819	F/790-16		
		24	0,6	0.024	21,3	0.839	F/790-17		
1"	(25,4)	12	2,8	0.109	19,9	0.782	F/790-17	BIT-F790-17÷22	5/8"
		14	2,1	0.083	21,2	0.834	F/790-18		
		16	1,6	0.065	22,0	0.870	F/790-19		
		18	1,2	0.049	22,9	0.902	F/790-20		
		20	0,9	0.035	23,6	0.930	F/790-21		
		22	0,7	0.028	24,0	0.944	F/790-22		
		24	0,6	0.024	24,5	0.965	F/790-23		
1.1/4"	(31,8)	12	2,8	0.109	26,2	1.032	F/790-23	BIT-F790-23÷32	3/4"
		14	2,1	0.083	27,5	1.084	F/790-24		
		16	1,6	0.065	28,4	1.120	F/790-25		
		18	1,2	0.049	29,3	1.152	F/790-26		
		20	0,9	0.035	30,0	1.180	F/790-27		
1.1/2"	(38,1)	12	2,8	0.109	32,6	1.282	F/790-28	BIT-F790-23÷32	1"
		14	2,1	0.083	33,9	1.334	F/790-29		
		16	1,6	0.065	34,8	1.370	F/790-30		
		18	1,2	0.049	35,6	1.402	F/790-31		
		20	0,9	0.035	36,3	1.430	F/790-32		

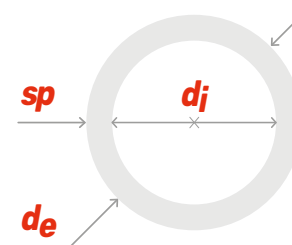
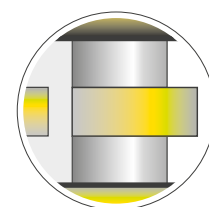
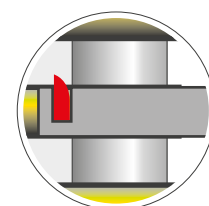

# F/791

## Tube reamer

These are high-speed steel reamers, with Morse taper connection and rear tang with diameter ground in accordance with the BWG of the tubes. To use to reduce the thickness of tubes to be replaced, for a depth of about 80% of the thickness of the sheet.

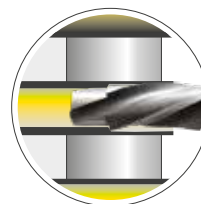

# F/793

## Tube expeller

Use preferably with a pneumatic hammer.  
Standard tang:  $\varnothing 17,2 \text{ mm}$  ( 0.677" ) x 60,3 mm ( 2.3/8" )

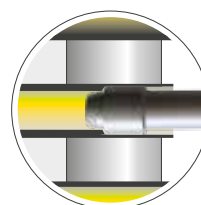

# F/792

## Tube collapsing tool

Used for crumpling tubes of non-ferrous alloys or ferrous alloys made lighter with the use of the reamer F/791 and expelling them from the tube plate. To be used preferably with a pneumatic hammer.  
Standard tang:  $\varnothing 17,2 \text{ mm}$  ( 0.677" ) x 60,3 mm ( 2.3/8" )

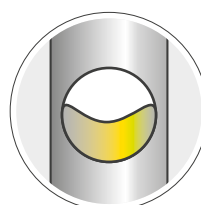

# F/789

## Pneumatic hammer specific for manual tools



<b>de</b>		<b>sp</b>		<b>dj</b>		<b>F/791</b>	<b>L1</b>		<b>F/793</b>	<b>L3</b>	<b>F/792</b>	<b>L2</b>				
"	mm	B.W.G	mm	inches	mm	inches	Cod.	mm	inches	Cod.	mm	inches				
1/2"	(12,9)	-	-	-	-	-	-			-	-	F/792-0	196,0	7,717		
5/8"	(15,9)	10	3,4	0.134	9,5	0.357	F/791-1	100,0	3.937	2	F/793-1	182,0	7.165	F/792-1	192,0	7.559
		11	3,0	0.120	9,8	0.385	F/791-2				F/793-2					
		12	2,8	0.109	10,3	0.407	F/791-3				F/793-3					
		13	2,4	0.095	11,0	0.435	F/791-4				F/793-4					
		14	2,1	0.083	11,7	0.459	F/791-5				F/793-5					
		15	1,8	0.072	12,2	0.481	F/791-6				F/793-6					
		16	1,6	0.065	12,6	0.495	F/791-7				F/793-7					
		18	1,2	0.049	13,4	0.527	F/791-8				F/793-8					
3/4"	(19,0)	10	3,4	0.134	12,2	0.482	F/791-9	120,0	4.724	2	F/793-9	182,0	7.165	F/792-2	194,0	7.638
		11	3,0	0.120	12,9	0.510	F/791-10				F/793-10					
		12	2,8	0.109	13,5	0.532	F/791-11				F/793-11					
		13	2,4	0.095	14,2	0.560	F/791-12				F/793-12					
		14	2,1	0.083	14,8	0.584	F/791-13				F/793-13					
		15	1,8	0.072	15,4	0.606	F/791-14				F/793-14					
		16	1,6	0.065	15,7	0.620	F/791-15				F/793-15					
		18	1,2	0.049	16,6	0.652	F/791-16				F/793-16					
7/8"	(22,2)	10	3,4	0.134	15,4	0.607	F/791-17	100,0	3.937	2	F/793-17	182,0	7.165	F/792-3	190,0	7.480
		11	3,0	0.120	16,1	0.635	F/791-18				F/793-18					
		12	2,8	0.109	16,7	0.657	F/791-19				F/793-19					
		13	2,4	0.095	17,4	0.685	F/791-20				F/793-20					
		14	2,1	0.083	18,0	0.709	F/791-21				F/793-21					
		15	1,8	0.072	18,6	0.731	F/791-22				F/793-22					
		16	1,6	0.065	18,9	0.745	F/791-23				F/793-23					
		18	1,2	0.049	19,7	0.777	F/791-24				F/793-24					
1"	(25,4)	8	4,2	0.165	17,0	0.670	F/791-25	155,0	6.102	3	F/793-25	182,0	7.165	F/792-4	177,0	6.969
		10	3,4	0.134	18,6	0.732	F/791-26				F/793-26					
		11	3,0	0.120	19,3	0.760	F/791-27				F/793-27					
		12	2,8	0.109	19,9	0.782	F/791-28				F/793-28					
		13	2,4	0.095	20,6	0.810	F/791-29				F/793-29					
		14	2,1	0.083	21,2	0.834	F/791-30				F/793-30					
		15	1,8	0.072	21,7	0.856	F/791-31				F/793-31					
		16	1,6	0.065	22,1	0.870	F/791-32				F/793-32					
1.1/4"	(31,8)	8	4,2	0.165	23,4	0.920	F/791-34	180,0	6.496	4	F/793-34	182,0	7.165	F/792-5	164,0	6.457
		10	3,4	0.134	24,9	0.982	F/791-35				F/793-35					
		11	3,0	0.120	25,6	1.010	F/791-36				F/793-36					
		12	2,8	0.109	26,2	1.032	F/791-37				F/793-37					
		13	2,4	0.095	26,9	1.060	F/791-38				F/793-38					
		14	2,1	0.083	27,5	1.084	F/791-39				F/793-39					
		16	1,6	0.065	28,4	1.120	F/791-40				F/793-40					
		18	1,2	0.049	29,7	1.170	F/791-41				F/793-41					
1.1/2"	(38,1)	10	3,4	0.134	31,3	1.232	F/791-42	180,0	7.087	4	F/793-42	182,0	7.165	F/792-6	165,0	6.496
		11	3,0	0.120	32,0	1.260	F/791-43				F/793-43					
		12	2,8	0.109	32,6	1.282	F/791-44				F/793-44					
		13	2,4	0.095	33,3	1.310	F/791-45				F/793-45					
		14	2,1	0.083	33,9	1.334	F/791-46				F/793-46					
		16	1,6	0.065	34,8	1.370	F/791-47				F/793-47					



# F/800



## Manual extractor

Recommended for small maintenance jobs, the F/800 hand extractor allows easy removal of stubs and tubes.

$d_e$		$sp$	$d_j m$		TPMM Mandrel	∅	TPCM Collar	F/800 Manual extractor	∅
"	mm	B.W.G	mm	inches	Cod.	inches	Cod.	Cod.	
3/8"	(9,5)	17 ÷ 19	6,5 ÷ 7,5	0.256 ÷ 0.295	TPMM-7	1/2"	TPCM-11	F/800-1	22 mm
		20 ÷ 24	7,5 ÷ 8,5	0.295 ÷ 0.335	TPMM-8				
1/2"	(12,7)	14 - 16	8,5 ÷ 9,5	0.335 ÷ 0.374	TPMM-9	1/2"	TPCM-14	F/800-1	22 mm
		17 - 18	9,5 ÷ 10,5	0.374 ÷ 0.413	TPMM-10				
		19 ÷ 21	10,5 ÷ 11,5	0.413 ÷ 0.453	TPMM-11				
		24	11,5 ÷ 12,5	0.453 ÷ 0.492	TPMM-12				
5/8"	(15,9)	16 - 17	12,5 ÷ 13,5	0.492 ÷ 0.531	TPMM-13	1/2"	TPCM-18	F/800-1	22 mm
		19 ÷ 21	13,5 ÷ 14,5	0.531 ÷ 0.571	TPMM-14				
		23 - 24	14,5 ÷ 15,5	0.571 ÷ 0.610	TPMM-15				
3/4"	(19,0)	11	12,5 ÷ 13,5	0.492 ÷ 0.531	TPMM-13	1/2"	TPCM-21	F/800-1	22 mm
		12 - 13	13,5 ÷ 14,5	0.531 ÷ 0.571	TPMM-14				
		14 - 15	14,5 ÷ 15,5	0.571 ÷ 0.610	TPMM-15				
		16 - 17	15,5 ÷ 16,5	0.610 ÷ 0.650	TPMM-16				
		18 ÷ 20	16,5 ÷ 17,5	0.650 ÷ 0.689	TPMM-17				
		21 ÷ 24	17,5 ÷ 18,5	0.689 ÷ 0.728	TPMM-18				
7/8"	(22,2)	14	17,5 ÷ 18,5	0.689 ÷ 0.728	TPMM-18	3/4"	TPCM-25	F/800-2	32 mm
		16 - 17	18,5 ÷ 19,5	0.728 ÷ 0.768	TPMM-19				
		18 - 19	19,5 ÷ 20,5	0.768 ÷ 0.807	TPMM-20				
1"	(25,4)	10 - 11	18,5 ÷ 19,5	0.728 ÷ 0.768	TPMM-19	3/4"	TPCM-28	F/800-2	32 mm
		12	19,5 ÷ 20,5	0.768 ÷ 0.807	TPMM-20				
		13 - 14	20,5 ÷ 21,5	0.807 ÷ 0.846	TPMM-21				
		15-16	21,5 ÷ 22,5	0.846 ÷ 0.886	TPMM-22				
		18	22,5 ÷ 23,5	0.886 ÷ 0.925	TPMM-23				
		19 - 20	23,5 ÷ 24,5	0.925 ÷ 0.965	TPMM-24				
1.1/4"	(31,8)	10	24,5 ÷ 25,5	0.995 ÷ 1.004	TPMM-25	1"	TPCM-34	F/800-3	46 mm
		11 - 12	25,5 ÷ 26,5	1.004 ÷ 1.043	TPMM-26				
		13	26,5 ÷ 27,5	1.043 ÷ 1.083	TPMM-27				
		14 - 15	27,5 ÷ 28,5	1.083 ÷ 1.122	TPMM-28				
		16 ÷ 18	28,5 ÷ 29,5	1.122 ÷ 1.161	TPMM-29				
		19 ÷ 22	29,5 ÷ 30,5	1.161 ÷ 1.201	TPMM-30				
1.1/2"	(38,1)	23 - 24	30,5 ÷ 31,5	1.201 ÷ 1.240	TPMM-31	1"	TPCM-41	F/800-3	46 mm
		10 - 11	31,5 ÷ 32,5	1.240 ÷ 1.280	TPMM-32				
		12 - 13	32,5 ÷ 33,5	1.280 ÷ 1.319	TPMM-33				
		14	33,5 ÷ 34,5	1.319 ÷ 1.358	TPMM-34				
		15 ÷ 17	34,5 ÷ 35,5	1.358 ÷ 1.398	TPMM-35				
		18 ÷ 20	35,5 ÷ 36,5	1.398 ÷ 1.437	TPMM-36				
		21 ÷ 24	36,5 ÷ 37,5	1.437 ÷ 1.476	TPMM-37				

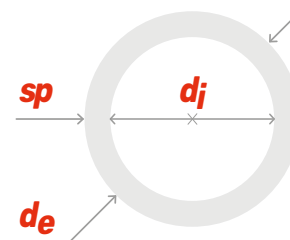

<b>d<sub>e</sub></b>		<b>sp</b>	<b>d<sub>j</sub></b>		<b>TPMM Mandrel</b>	☒	<b>TPCM Collar</b>	<b>F/800 Manual extractor</b>	☒
"	mm	B.W.G	mm	inches	Cod.	inches	Cod.	Cod.	
2"	(50,8)	10	43,5 ÷ 44,5	1.713 ÷ 1.752	TPMM-44	1.1/4"	TPCM-56	F/800-4	hexagon 55 mm
		11 - 12	44,5 ÷ 45,5	1.752 ÷ 1.791	TPMM-45				
		13	45,5 ÷ 46,5	1.791 ÷ 1.831	TPMM-46				
		14 - 15	46,5 ÷ 47,5	1.831 ÷ 1.870	TPMM-47				
		16 ÷ 18	47,5 ÷ 48,5	1.870 ÷ 1.909	TPM-48				
		19 ÷ 22	48,5 ÷ 49,5	1.909 ÷ 1.949	TPM-49				

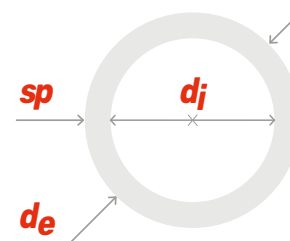

## TPMM Mandrel



## TPCM Collar



## F/800 Manual extractor



## Manual key



# BWG Table

OD " mm	00 BWG		0 BWG		1 BWG		2 BWG		3 BWG		4 BWG		5 BWG		6 BWG		7 BWG		8 BWG		9 BWG		10 BWG		11 BWG			
	"	mm	"	mm	"	mm	"	mm	"	mm	"	mm	"	mm	"	mm	"	mm	"	mm	"	mm	"	mm	"	mm		
SP →	0.380	9,65	0.340	8,64	0.300	7,62	0.284	7,21	0.259	6,58	0.238	6,05	0.220	5,59	0.203	5,16	0.180	4,57	0.165	4,19	0.148	3,76	0.134	3,40	0.120	3,05		
1/4" (6,3)	-	-	-	-	-	-	-	-	-	-	-	-	-	-	-	-	-	-	-	-	-	-	-	-	-	-	-	-
3/8" (9,5)	-	-	-	-	-	-	-	-	-	-	-	-	-	-	-	-	-	-	-	-	-	-	-	-	-	-	-	-
1/2" (12,7)	-	-	-	-	-	-	-	-	-	-	-	-	-	-	-	-	-	-	-	-	-	-	-	-	-	-	-	-
5/8" (15,9)	-	-	-	-	-	-	-	-	-	-	-	-	-	-	-	-	-	-	-	-	-	-	-	-	-	-	-	-
3/4" (19,0)	-	-	-	-	-	-	-	-	-	-	-	-	-	-	-	-	-	-	-	-	-	-	-	-	0.482	12,2	0.510	12,9
7/8" (22,2)	-	-	-	-	-	-	-	-	-	-	-	-	-	-	-	-	-	-	-	-	-	-	-	-	0.607	15,4	0.635	16,1
1" (25,4)	-	-	-	-	-	-	-	-	-	-	-	-	-	-	-	-	0.670	17,0	0.704	17,9	0.732	18,6	0.760	19,3				
1.1/4" (31,8)	-	-	-	-	-	-	-	-	-	-	-	-	-	-	-	-	0.890	22,6	0.920	23,4	0.954	24,3	0.982	25,0	1.010	25,7		
1.1/2" (38,1)	-	-	-	-	-	-	-	-	-	-	-	-	-	-	-	-	1.140	28,9	1.170	29,7	1.204	30,6	1.232	31,3	1.260	32,0		
1.3/4" (44,4)	-	-	-	-	-	-	-	-	-	-	-	-	1.310	33,2	1.344	34,1	1.390	35,2	1.420	36,0	1.454	36,9	1.482	37,6	1.510	38,3		
2" (50,8)	-	-	-	-	-	-	-	-	-	-	1.524	38,7	1.560	39,6	1.594	40,5	1.640	41,6	1.670	42,4	1.704	43,3	1.732	44,0	1.760	44,7		
2.1/4" (57,1)	1.490	37,8	1.570	39,8	1.650	41,8	1.682	42,7	1.732	43,9	1.774	45,0	1.810	45,9	1.844	46,8	1.890	47,9	1.920	48,7	1.954	49,6	1.982	50,3	2.010	51,0		
2.1/2" (63,5)	1.740	44,2	1.820	46,2	1.900	48,2	1.932	49,1	1.982	50,3	2.024	51,4	2.060	52,3	2.094	53,2	2.140	54,3	2.170	55,1	2.204	56,0	2.232	56,7	2.260	57,4		
2.3/4" (69,8)	1.990	50,5	2.070	52,5	2.150	54,5	2.182	55,3	2.232	56,6	2.274	57,7	2.310	58,6	2.344	59,5	2.390	60,6	2.420	61,4	2.454	62,3	2.482	63,0	2.510	63,7		
3" (76,2)	2.240	56,9	2.320	58,9	2.400	60,9	2.432	61,8	2.482	63,0	2.524	64,1	2.560	65,0	2.594	65,9	2.640	67,0	2.670	67,8	2.704	68,7	2.732	69,4	2.760	70,1		
3.1/4" (82,6)	2.490	63,3	2.570	65,3	2.650	67,3	2.682	68,2	2.732	69,4	2.774	70,5	2.810	71,4	2.844	72,3	2.890	73,4	2.920	74,2	2.954	75,1	2.982	75,8	3.010	76,5		
3.1/2" (88,9)	2.740	69,6	2.820	71,6	2.900	73,6	2.932	74,5	2.982	75,7	3.024	76,8	3.060	77,7	3.094	78,6	3.140	79,7	3.170	80,5	3.204	81,4	3.232	82,1	3.260	82,8		
3.3/4" (95,2)	2.990	75,9	3.070	77,9	3.150	79,9	3.182	80,8	3.232	82,0	3.274	83,1	3.310	84,0	3.344	84,9	3.390	86,0	3.420	86,8	3.454	87,7	3.482	88,4	3.510	89,1		
4" (101,6)	3.240	82,3	3.320	84,3	3.400	86,3	3.432	87,2	3.482	88,4	3.524	89,5	3.560	90,4	3.594	91,3	3.640	92,4	3.670	93,2	3.704	94,1	3.732	94,8	3.760	95,5		
4.1/4" (108,0)	3.490	88,7	3.570	90,7	3.650	92,7	3.682	93,6	3.732	94,8	3.774	95,9	3.810	96,8	3.844	97,7	3.890	98,8	3.920	99,6	3.954	100,5	3.982	101,2	4.010	101,9		
4.1/2" (114,3)	3.740	95,0	3.820	97,0	3.900	99,0	3.932	99,9	3.982	101,1	4.024	102,2	4.060	103,1	4.094	104,0	4.140	105,1	4.170	105,9	4.204	106,8	4.232	107,5	4.260	108,2		

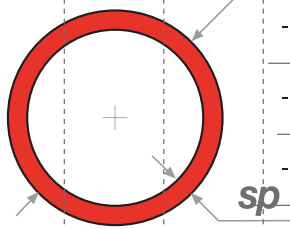

12 BWG		13 BWG		14 BWG		15 BWG		16 BWG		17 BWG		18 BWG		19 BWG		20 BWG		21 BWG		22 BWG		23 BWG		24 BWG		OD														
“	mm	“	mm	“	mm	“	mm	“	mm	“	mm	“	mm	“	mm	“	mm	“	mm	“	mm	“	mm	“	mm	“	mm	“	mm	“	mm									
0.109	2,77	0.095	2,41	0.083	2,11	0.072	1,83	0.065	1,65	0.058	1,47	0.049	1,24	0.042	1,07	0.035	0,89	0.032	0,81	0.028	0,71	0.025	0,64	0.022	0,56									← <i>sp</i>						
-	-	-	-	-	-	-	-	-	-	-	-	0.152	3,8	0.166	4,1	0.180	4,5	0.186	4,7	0.194	4,9	0.200	5,0	0.206	5,2											1/4" (6,3)				
-	-	-	-	0.209	5,3	0.231	5,8	0.245	6,2	0.259	6,5	0.277	7,0	0.291	7,3	0.305	7,7	0.311	7,9	0.319	8,1	0.325	8,2	0.331	8,4													3/8" (9,5)		
-	-	0.310	7,9	0.334	8,5	0.356	9,0	0.370	9,4	0.384	9,7	0.402	10,2	0.416	10,5	0.430	10,9	0.436	11,1	0.444	11,3	0.450	11,4	0.456	11,6													1/2" (12,7)		
0.407	10,3	0.435	11,1	0.459	11,7	0.481	12,2	0.495	12,6	0.509	12,9	0.527	13,4	0.541	13,7	0.555	14,1	0.561	14,3	0.569	14,5	0.575	14,6	0.581	14,8													5/8" (15,9)		
0.532	13,4	0.560	14,2	0.584	14,8	0.606	15,3	0.620	15,7	0.634	16,0	0.652	16,5	0.666	16,8	0.680	17,2	0.686	17,4	0.694	17,6	0.700	17,7	0.706	17,9													3/4" (19,0)		
0.657	16,6	0.685	17,4	0.709	18,0	0.731	18,5	0.745	18,9	0.759	19,2	0.777	19,7	0.791	20,0	0.805	20,4	0.811	20,6	0.819	20,8	0.825	20,9	0.831	21,1															7/8" (22,2)
0.782	19,8	0.810	20,6	0.834	21,2	0.856	21,7	0.870	22,1	0.884	22,4	0.902	22,9	0.916	23,2	0.930	23,6	0.936	23,8	0.944	24,0	0.950	24,1	0.956	24,3															1" (25,4)
1.032	26,2	1.060	27,0	1.084	27,6	1.106	28,1	1.120	28,5	1.134	28,8	1.152	29,3	1.166	29,6	1.180	30,0	1.186	30,2	1.194	30,4	1.200	30,5	1.206	30,7															1 1/4" (31,8)
1.282	32,5	1.310	33,3	1.334	33,9	1.356	34,4	1.370	34,8	1.384	35,1	1.402	35,6	1.416	35,9	1.430	36,3	1.436	36,5	1.444	36,7	1.450	36,8	1.456	37,0															1 1/2" (38,1)
1.532	38,8	1.560	39,6	1.584	40,2	1.606	40,7	1.620	41,1	1.634	41,4	1.652	41,9	1.666	42,2	1.680	42,6	1.686	42,8	1.694	43,0	1.700	43,1	1.706	43,3															1 3/4" (44,4)
1.782	45,2	1.810	46,0	1.834	46,6	1.856	47,1	1.870	47,5	1.884	47,8	1.902	48,3	1.916	48,6	1.930	49,0	1.936	49,2	1.944	49,4	1.950	49,5	1.956	49,7															2" (50,8)
2.032	51,5	2.060	52,3	2.084	52,9	2.106	53,4	2.120	53,8	2.134	54,1	2.152	54,6	-	-	-	-	-	-	-	-	-	-	-	-															2 1/4" (57,1)
2.282	57,9	2.310	58,7	2.334	59,3	2.356	59,8	2.370	60,2	2.384	60,5	2.402	61,0	-	-	-	-	-	-	-	-	-	-	-	-															2 1/2" (63,5)
2.532	64,2	2.560	65,0	2.584	65,6	2.606	66,1	2.620	66,5	2.634	66,8	2.652	67,3	-	-	-	-	-	-	-	-	-	-	-	-															2 3/4" (69,8)
2.782	70,6	2.810	71,4	2.834	72,0	2.856	72,5	2.870	72,9	2.884	73,2	2.902	73,7	-	-	-	-	-	-	-	-	-	-	-	-															3" (76,2)
3.032	77,0	3.060	77,8	3.084	78,4	3.106	78,9	3.120	79,3	3.134	79,6	3.152	80,1	-	-	-	-	-	-	-	-	-	-	-	-															3 1/4" (82,6)
3.282	83,3	3.310	84,1	3.334	84,7	3.356	85,2	3.370	85,6	3.384	85,9	3.402	86,4	-	-	-	-	-	-	-	-	-	-	-	-															3 1/2" (88,9)
3.532	89,6	3.560	90,4	3.584	91,0	3.606	91,5	3.620	91,9	3.634	92,2	3.652	92,7	-	-	-	-	-	-	-	-	-	-	-	-															3 3/4" (95,2)
3.782	96,0	3.810	96,8	3.834	97,4	3.856	97,9	3.870	98,3	3.884	98,6	3.902	99,1	-	-	-	-	-	-	-	-	-	-	-	-															4" (101,6)
4.032	102,4	4.060	103,2	4.084	103,8	4.106	104,3	4.120	104,7	4.134	105,0	4.152	105,5	-	-	-	-	-	-	-	-	-	-	-	-															4 1/4" (108,0)
4.282	108,7	4.310	109,5	4.334	110,1	4.356	110,6	4.370	111,0	4.384	111,3	4.402	111,8	-	-	-	-	-	-	-	-	-	-	-	-															4 1/2" (114,3)





**Maus Italia S.p.A.**

SP 415 KM 30 ( nuova strada di arrocco )  
26010 Bagnolo Cremasco ( CR ) Italy  
PIVA: 00141010199

Telefono: +39 0373 2370

[expo@mausitalia.it](mailto:expo@mausitalia.it)  
[www.mausitalia.it](http://www.mausitalia.it)

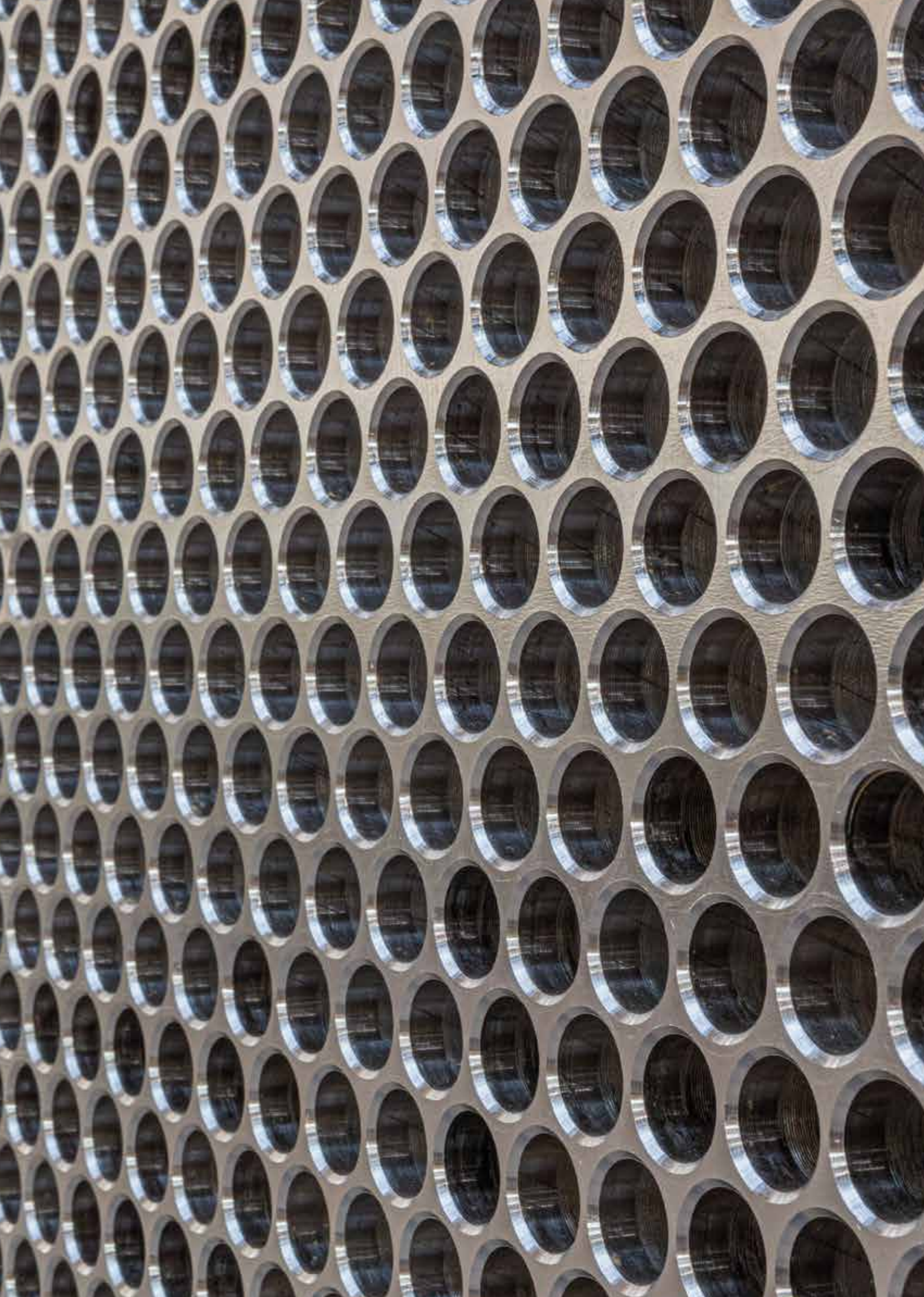





**mausitalia.it**

